

meite®

CATALOGUE

TOOLS FOR PROFESSIONALS

PROFESSIONAL TOOLS & FASTENERS



meite®

Guangdong Meite Mechanical Co., Ltd

Add: NO.10, Shunjing St., Hegui Industrial Park(B), Lishui Town, Nanhai District, Foshan, GD 528241, China

Tel : (0086)757-85126856

Fax : (0086)757-85126850



www.meitertools.com



meite®

A complete pneumatic tools, fasteners and accessories supplier.

Established in 1996, Guangdong Meite Mechanical Co., Ltd. is a professional pneumatic products company involving in combination of R&D, manufacturing, sale and service. Meite offers a complete range of air nailers & staplers, fasteners, accessories, compressors, spray guns and air tools for different industries. After 20 plus years rapid development, Meite has become a leading manufacturer for pneumatic products in China.

Since its foundation, Meite introduced the up-to-date technology from all over the world. And our 70,000m² plants are equipped with the latest CNC machineries, heat treatment, forging and painting equipments etc. Meite is desired to build a manufacturing base for pneumatic products in China.

Everything begins with the customers. Meite always listens to the users in the field and produces the tools and fasteners to fit their needs. Meite is committed to providing high quality products and professional services for the global customers.



END TO END MANUFACTURING



Casting

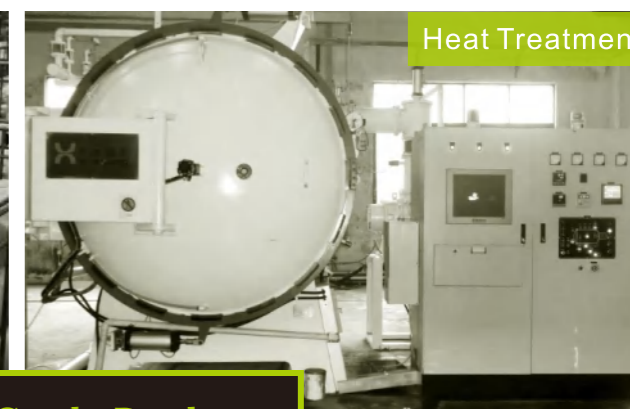

Heat Treatment

Professional Grade Products







CNC Machining



Assembling

A ISO 9001 CERTIFICATED MANUFACTURER

Industrial Coil Nailer

CN55B	CN70E	CN70DS	CN100EPAL
			
Pg.09	Pg.12	Pg.13	Pg.16

C Ring Plier / Clipper

SC760C	M66L
	
Pg.23	Pg.28

Headless / Mini Brad Pinner

MT840	MT850
	
Pg.35	Pg.36

Fine / Medium / Heavy Wire Stapler

MTP8016	MT432KLM	MT-N851-H	N851-L
			
Pg.42	Pg.48	Pg.50	Pg.51

Concrete & Steel Nailer

CS3025	MTCS3040
	
Pg.64	Pg.65

NEW
PRODUCTS
AT A GLANCE

Construction Coil Nailer CN452S	P08
Industrial Coil Nailer CN55, CN55B, CN55K, CN55C, CN65B, CN70B, CN70C, CN70E, CN70DS, CN80B, CN80DS, CN80E, CN90, CN100B, CN100, CN100EPAL, CN100DS, CN130	P08-17
Industrial Strip Nailer SF13021	P17
De-Nailer T50SC, NP55, NP70	P19
Wire Collated Coil Nails	P21
C-Ring Plier SC760B, SC760C, SC7C, SC7C-P, SC7E, SC7E-P, SC77XE, MT-HC45	P23-27
Industrial Stapling Plier P88U	P27
Clipping Tool M66L, M66B, M65B, M46B, M45B	P28-29
C-Rings & Clips	P31
Headless Pinner MP622, P630C, MP630, MP635, MP650B, MT840, MT850	P33-36
Headless Pins	P37
Fine Wire Stapler MT7116, MT7116S, MT7116LN, 7116, 7116C, 7116B, MT8016, MT8016S, MT8016LN, 8016D, 8016F, 8016B, MTP8016, MTP5016, MT5016, MT5016S, MT5016SLN, 1416, 1416B, MT425J, 422J, MT1025J, 1022J	P39-47
Medium Wire Stapler MT432KLM, MT440KLM, 440KB, 9240B, 635TR	P48-49
Heavy Wire Stapler MT-N851-H, N851-L, N851F, PW2638-L	P50-52
Fine Wire Staples	P54-55
Medium Wire Staples	P56
Heavy Wire Staples	P56
Brad Nailer MTF32, F32D, F32, F50G, F50C, T64A, T50SA, T50MA, FST50, ST64	P58-62
Concrete And Steel Nailer CS3025, MTCS3040L, MTCS3040, MT-G38	P64-65
Picture Frame Tacker P515, HM515, HF18, V1015B	P67-68
Deco Nailer ZN1400, ZN-12	P69
Carton Closing Stapler HB3515, HB3518, ADCS-19, ADCS-22, RATA-19, RAIA-19	P71-73
Special Tools MFS50, TH-1213F	P75
Accessories	P76



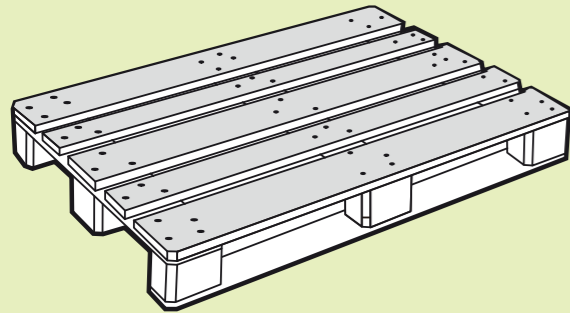

APPLICATIONS	TOOL SERIES	MODEL	PAGE
Pallets	Coil Nailer	CN55 CN55B	8, 9
		CN55C CN55K	9, 10
		CN65B	10
		CN70B CN70C	11
		CN70E CN70DS	12, 13
		CN80B	14
		CN90	14
		CN100B CN100 CN100EPAL	15, 16
		CN130	17
		Nail Puller	T50SC NP55 NP70
Crates/ Wood Case	Coil Nailer	N851F MT-N851-H N851-L	50, 51, 52
		PW2638-L	52
Packaging	Coil Nailer	SF13021	17
		TH-1213F	75
		HB3515 HB3518	71
		ADCS-19 ADCS-22	72
		RATA-19 RAIA-19	73
Packaging	Carton Closing Stapler	HB3515 HB3518	71
		ADCS-19 ADCS-22	72
		RATA-19 RAIA-19	73

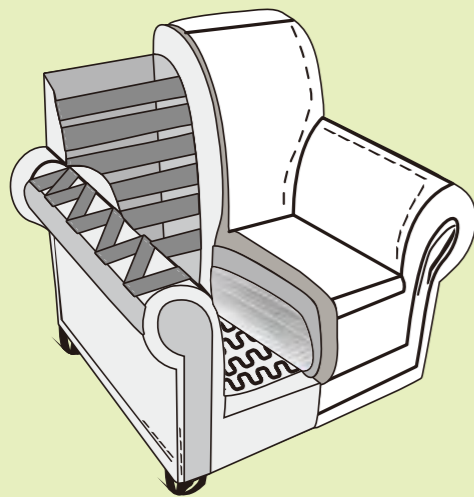

APPLICATIONS	TOOL SERIES	MODEL	PAGE	
Furniture	Fine Wire Stapler	MT7116 7116 7116B 7116C	39, 43, 44, 45	
		MT8016 8016B 8016D 8016F	39, 45, 43, 44	
Cabinets	Fine Wire Stapler	1022J	46	
		422J	46	
Bedding	Medium Wire Stapler	MT5016 MTP5016	39, 42	
		MT425J MT1025J	47	
		1416 1416B	43, 45	
		MT432KLM MT440KLM	48	
		440KB	49	
		9240B	49	
		635TR	49	
		Heavy Wire Stapler	N851F MT-N851-H N851-L	50, 51, 52
			PW2638-L	52
		Cabinets	Brad Nailer	MTF32 F32 F32D F50C F50G
T64A T50MA FST50	60, 61, 62			
Cabinets	Headless Pinner Nailer	MP622 MP630	33, 34	
		MP635 MP650B	34, 35	
		MP840 MP850	35, 36	

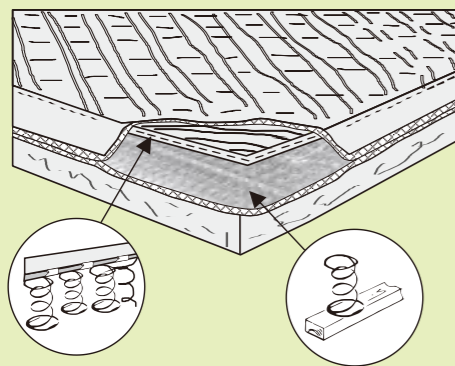

APPLICATIONS	TOOL SERIES	MODEL	PAGE
Spring Mattress	C-Ring Plier	SC7C SC7C-P	24
		SC7E SC7E-P	25
		SC760B SC760C SC77XE	23, 26
Car Seat	Clipping Tool	M66 M66L M65	28, 29
		M46 M45	29
Car Seat	Stapling Plier	P88U	27
Car Seat	Fine Wire Stapler	MT7116 7116 7116B 7116C	39, 43, 44, 45
		MT8016 8016B 8016D 8016F	39, 45, 43, 44
		1022J	46
		422J	46
		MT5016 MTP5016	39, 42
		MT425J MT1025J	47
		1416 1416B	43, 45

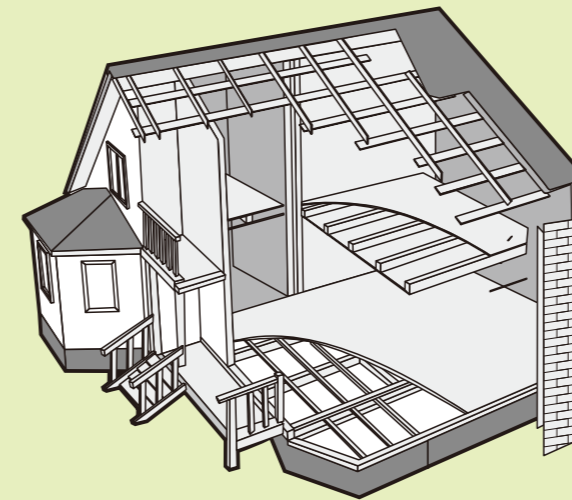

APPLICATIONS	TOOL SERIES	MODEL	PAGE
Flooring	Flooring Nailer	MFS50	75
Decking	Construction Coil Nailer	CN452S	8
		CN55 CN55B	8, 9
Siding	Coil Nailer	CN55C CN55K	9, 10
		CN70B CN70C CN70E	11, 12
Sheathing	Coil Nailer	CN80B	14
		CN90	14
Fencing	Heavy Wire Stapler	N851F MT-N851-H N851-L	50, 51, 52
		Concrete and Steel Nailer	CS3025
Windows Door	Fine Wire Stapler	MT7116 7116 7116B 7116C	39, 43, 44, 45
		MT8016 8016B 8016D 8016F	39, 45, 43, 44
		1022J	46
		422J	46
		MT5016 MTP5016	39, 42
		MT425J MT1025J	47
		1416 1416B	43, 45
		MT432KLM MT440KLM	48
		440KB	49
		9240B	49
635TR	49		
Windows Door	Heavy Wire Stapler	MT-N851-H N851-L	50, 51, 52
		N851F PW2638-L	52
Windows Door	Brad Nailer	MTF32 F32 F32D F50C	58, 59, 60
Interior Decoration	Headless Pinner Nailer	MP622 MP630	33, 34
		MP635 MP650B	34, 35
		MP840 MP850	35, 36

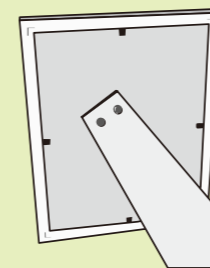

APPLICATIONS	TOOL SERIES	MODEL	PAGE
Picture Frame	Flex Point Tacker	HM515	67
		P515	67
	Hard Point Tacker	HF18	68
		V-Nailer	V1015B
	Headless Pinner Nailer	MP622 MP630	33, 34
		MP635 MP650B	34, 35
Mini Brad Pinner	MP840 MP850	35, 36	



Construction Coil Nailer

15° COIL NAIL CN452S 2" Coil Nailer

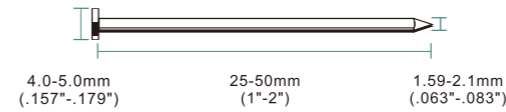

FEATURES	APPLICATIONS
▶ Switchable firing mode	▶ Siding
▶ 360° exhaust deflector	▶ Decking
▶ Light weight & well-balanced	▶ Fencing
▶ Adjustable depth control	▶ Sheathing
▶ No-mar tip	

FASTENER	SIMILAR TOOLS
Type: Wire / Plastic Collated Coil Nails	▶ MAX CN452S
Length: 25-50mm(1"-2")	
Shank Dia.: 1.59-2.1mm(.062\"-.082")	
Head Dia.: 4.0-5.0mm(.157\"-.179")	
Nail Pitch: 6.0mm(.236")	
Shank Type: Smooth, Screw & Ring	

TOOL SPECIFICATIONS			
Weight:	1.86kg/4.10lbs	Capacity:	Wire:400pcs/Plastic:200pcs
Height:	300mm/11.81"	Operating Pressure:	60-100psi
Length:	287mm/11.29"	Air Inlet:	1/4"NPT
Width:	110mm/4.33"	Trigger:	Contact

Industrial Coil Nailer

15° COIL NAIL CN55 2 1/4" Coil Nailer

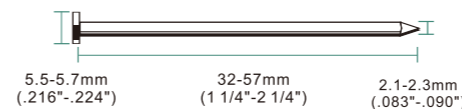

FEATURES	APPLICATIONS
▶ Powerful for heavy-duty applications	▶ Pallets
▶ Well-balanced, comfort rubber grip	▶ Crates & Wood Cases
▶ Bump firing trigger for high speed operation	▶ Sheathing
▶ Durable driver and bumper for long life	▶ Siding
▶ Accurate nose, minimize nail jam	▶ Fencing
	▶ Decking

FASTENER	SIMILAR TOOLS
Type: Wire Collated Coil Nails	▶ MAX CN55
Length: 32-57mm(1 1/4"-2 1/4")	▶ BeA 550DC
Shank Dia.: 2.1-2.3mm(.082\"-.090")	▶ Bostitch N57C
Head Dia.: 5.5-5.7mm(.216\"-.224")	▶ SENCO Pallet Pro 57F
Nail Pitch: 6.8mm(.267")	
Shank Type: Smooth, Screw & Ring	

TOOL SPECIFICATIONS			
Weight:	2.75kg/6.06lbs	Capacity:	300-400pcs
Height:	283mm/11.14"	Operating Pressure:	70-100psi
Length:	270mm/10.62"	Air Inlet:	1/4"NPT
Width:	131mm/5.15"	Trigger:	Contact

15° COIL NAIL CN55B 2 1/4" Coil Nailer / Extra Power

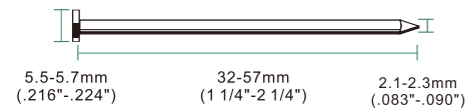

FEATURES

- ▶ Powerful for heavy-duty applications
- ▶ Well-balanced, comfort rubber grip
- ▶ Bump firing trigger for high speed operation
- ▶ Durable driver and bumper for long life
- ▶ Accurate nose, minimize nail jam

APPLICATIONS

- ▶ Pallets
- ▶ Crates & Wood Cases
- ▶ Sheathing
- ▶ Siding
- ▶ Fencing
- ▶ Decking

FASTENER

Type:	Wire Collated Coil Nails
Length:	32-57mm (1 1/4"-2 1/4")
Shank Dia.:	2.1-2.3mm (.082"-.090")
Head Dia.:	5.5-5.7mm (.216"-.224")
Nail Pitch:	6.8mm (.267")
Shank Type:	Smooth, Screw & Ring

SIMILAR TOOLS

- ▶ MAX CN55
- ▶ BeA 550DC
- ▶ Bostitch N57C
- ▶ SENCO Pallet Pro 57F

TOOL SPECIFICATIONS

Weight:	2.9kg/6.39lbs	Capacity:	300-400pcs
Height:	315mm/12.40"	Operating Pressure:	70-100psi
Length:	270mm/10.62"	Air Inlet:	1/4"NPT
Width:	131mm/5.15"	Trigger:	Contact

15° COIL NAIL CN55C 2 1/4" Coil Nailer

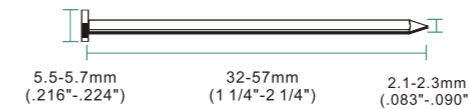

FEATURES

- ▶ Powerful for heavy-duty applications
- ▶ Well-balanced, comfort rubber grip
- ▶ Bump firing trigger for high speed operation
- ▶ Durable driver and bumper for long life
- ▶ Accurate nose, minimize nail jam

APPLICATIONS

- ▶ Pallets
- ▶ Crates & Wood Cases
- ▶ Sheathing
- ▶ Siding
- ▶ Fencing
- ▶ Decking

FASTENER

Type:	Wire Collated Coil Nails
Length:	32-57mm (1 1/4"-2 1/4")
Shank Dia.:	2.1-2.3mm (.082"-.090")
Head Dia.:	5.5-5.7mm (.216"-.224")
Nail Pitch:	6.8mm (.267")
Shank Type:	Smooth, Screw & Ring

SIMILAR TOOLS

- ▶ MAX CN55
- ▶ BeA 550DC
- ▶ Bostitch N57C
- ▶ SENCO Pallet Pro 57F

TOOL SPECIFICATIONS

Weight:	2.57kg/5.67lbs	Capacity:	300-400pcs
Height:	270mm/10.62"	Operating Pressure:	70-100psi
Length:	300mm/11.81"	Air Inlet:	1/4"NPT
Width:	135mm/5.31"	Trigger:	Contact

15° COIL NAIL CN55K 2 1/4" Coil Nailer / Depth Control

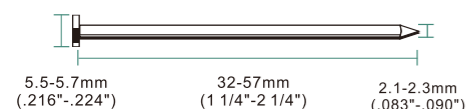

FEATURES

- ▶ Powerful for heavy-duty applications
- ▶ Well-balanced, comfort rubber grip
- ▶ Bump firing trigger for high speed operation
- ▶ Durable driver and bumper for long life
- ▶ Accurate nose, minimize nail jam

APPLICATIONS

- ▶ Pallets
- ▶ Crates & Wood Cases
- ▶ Sheathing
- ▶ Siding
- ▶ Fencing
- ▶ Decking

FASTENER

Type:	Wire Collated Coil Nails
Length:	32-57mm (1 1/4"-2 1/4")
Shank Dia.:	2.1-2.3mm (.082"-.090")
Head Dia.:	5.5-5.7mm (.216"-.224")
Nail Pitch:	6.8mm (.267")
Shank Type:	Smooth, Screw & Ring

SIMILAR TOOLS

- ▶ MAX CN55
- ▶ BeA 550DC
- ▶ Bostitch N57C
- ▶ SENCO Pallet Pro 57F

TOOL SPECIFICATIONS

Weight:	2.75kg/6.06lbs	Capacity:	300-400pcs
Height:	283mm/11.14"	Operating Pressure:	70-100psi
Length:	270mm/10.62"	Air Inlet:	1/4"NPT
Width:	131mm/5.15"	Trigger:	Contact

15° COIL NAIL CN65B 2 1/2" Coil Nailer

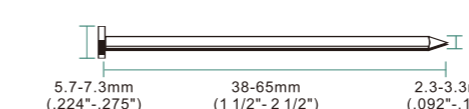

FEATURES

- ▶ 360° exhaust deflector
- ▶ Light weight and well-balanced
- ▶ Bump firing trigger for high speed operation
- ▶ Durable driver and bumper for long life

APPLICATIONS

- ▶ Pallets
- ▶ Crates & Wood Cases
- ▶ Sheathing
- ▶ Siding
- ▶ Fencing
- ▶ Decking

FASTENER

Type:	Wire Collated Coil Nails
Length:	38-65mm (1 1/2"-2 1/2")
Shank Dia.:	2.3-3.3mm (.090"-.129")
Head Dia.:	5.7-7.3mm (.224"-.287")
Nail Pitch:	8mm (.314")
Shank Type:	Smooth, Screw & Ring

SIMILAR TOOLS

- ▶ MAX CN665

TOOL SPECIFICATIONS

Weight:	2.96kg/6.53lbs	Capacity:	300pcs
Height:	328mm/12.91"	Operating Pressure:	70-100psi
Length:	310mm/12.20"	Air Inlet:	1/4"NPT
Width:	130mm/5.11"	Trigger:	Contact

15°
COIL NAIL **CN70B**
2 3/4" Coil Nailer

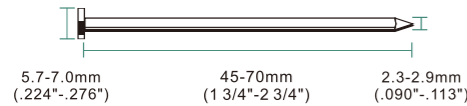

FEATURES

- ▶ Powerful for heavy-duty applications
- ▶ Well-balanced, comfort rubber grip
- ▶ Bump firing trigger for high speed operation
- ▶ Durable driver and bumper for long life
- ▶ Accurate nose, minimize nail jam

APPLICATIONS

- ▶ Pallets
- ▶ Crates & Wood Cases
- ▶ Framing
- ▶ Decking
- ▶ Fencing
- ▶ Packaging

FASTENER

Type:	Wire Collated Coil Nails
Length:	45-70mm(1 3/4"-2 3/4")
Shank Dia.:	2.3-2.9mm(.090"-.114")
Head Dia.:	5.7-7.0mm(.224"-.275")
Nail Pitch:	8mm(.314")
Shank Type:	Smooth, Screw & Ring

SIMILAR TOOLS

- ▶ MAX CN70
- ▶ Bostitch N70CB
- ▶ BeA 700DC

TOOL SPECIFICATIONS

Weight:	3.84kg/8.47lbs	Capacity:	225-300pcs
Height:	318mm/12.51"	Operating Pressure:	70-100psi
Length:	336mm/13.22"	Air Inlet:	1/4"NPT
Width:	143mm/5.62"	Trigger:	Contact

15°
COIL NAIL **CN70C**
2 3/4" Coil Nailer

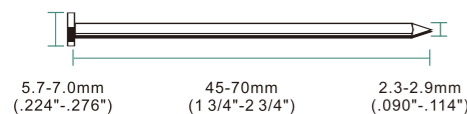

FEATURES

- ▶ Powerful for heavy-duty applications
- ▶ Well-balanced, comfort rubber grip
- ▶ Bump firing trigger for high speed operation
- ▶ Durable driver and bumper for long life
- ▶ Accurate nose, minimize nail jam

APPLICATIONS

- ▶ Pallets
- ▶ Crates & Wood Cases
- ▶ Framing
- ▶ Decking
- ▶ Fencing
- ▶ Packaging

FASTENER

Type:	Wire Collated Coil Nails
Length:	45-70mm(1 3/4"-2 3/4")
Shank Dia.:	2.3-2.9mm(.090"-.114")
Head Dia.:	5.7-7.0mm(.224"-.275")
Nail Pitch:	8mm(.314")
Shank Type:	Smooth, Screw & Ring

SIMILAR TOOLS

- ▶ MAX CN70
- ▶ Bostitch N70CB
- ▶ BeA 700DC

TOOL SPECIFICATIONS

Weight:	3.84kg/8.47lbs	Capacity:	225-300pcs
Height:	318mm/12.51"	Operating Pressure:	70-100psi
Length:	336mm/13.22"	Air Inlet:	1/4"NPT
Width:	143mm/5.62"	Trigger:	Contact

Tool Mounted on Automatic Pallet Machine

15°
COIL NAIL **CN70E**
2 3/4" Coil Nailer



FEATURES

- ▶ Tool for automatic pallet machine
- ▶ Powerful for heavy-duty applications
- ▶ Rapid firing trigger for high speed operation
- ▶ Durable driver and bumper for long life
- ▶ Accurate nose to minimize nail jam

APPLICATIONS

- ▶ Pallets

FASTENER

	CN70E	CN80E
Type:	Wire Collated Coil Nails	Wire Collated Coil Nails
Length:	45-70mm(1 3/4"-2 3/4")	45-83mm(1 3/4"-3 1/4")
Shank Dia.:	2.3-2.9mm(.090"-.114")	2.5-3.1mm(.098"-.122")
Head Dia.:	5.7-7.0mm(.224"-.275")	6.0-7.0mm(.236"-.275")
Nail Pitch:	8mm(.314")	8mm(.314")
Shank Type:	Smooth, Screw & Ring	Smooth, Screw & Ring

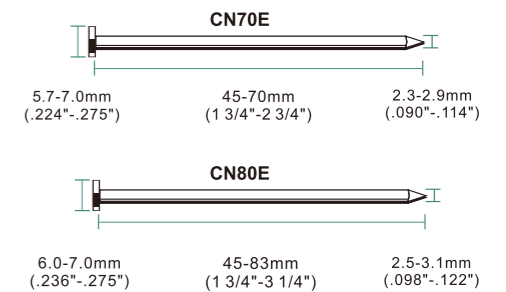

TOOL SPECIFICATIONS

	CN70E	CN80E
Weight:	3.05kg/6.72lbs	4.02kg/8.86lbs
Height:	318mm/12.51"	348mm/13.70"
Length:	338mm/13.30"	347mm/13.66"
Width:	112mm/4.40"	137mm/5.39"
Capacity:	3000pcs	3000pcs
Operating Pressure:	70-100psi	70-100psi
Air Inlet:	1/4"NPT	1/4"NPT
Trigger:	Remote Control	Remote Control



Secondary Safety Handle

15° COIL NAIL **CN70DS**
2 3/4" Coil Nailer



BOTH HANDS REQUIRED
FOR ACTUATION
HELPS **MINIMIZE** ACCIDENTS

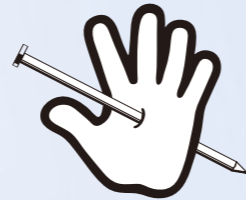

NO MORE

15° COIL NAIL **CN80B**
3 1/4" Coil Nailer

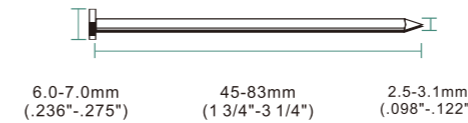

FEATURES

- ▶ Powerful for heavy-duty applications
- ▶ Well-balanced, comfort rubber grip
- ▶ Bump firing trigger for high speed operation
- ▶ Durable driver and bumper for long life
- ▶ Accurate nose, minimize nail jam

APPLICATIONS

- ▶ Pallets
- ▶ Crates & Wood Cases
- ▶ Packaging
- ▶ Decking
- ▶ Sheathing

FASTENER

Type:	Wire Collated Coil Nails
Length:	45-83mm(1 3/4"-3 1/4")
Shank Dia.:	2.5-3.1mm(.098"-.122")
Head Dia.:	6.0-7.0mm(.236"-.275")
Nail Pitch:	8mm(.314")
Shank Type:	Smooth, Screw & Ring

SIMILAR TOOLS

- ▶ MAX CN80
- ▶ Bostitch N80CB
- ▶ BeA 800DC

TOOL SPECIFICATIONS

Weight:	4.02kg/8.86lbs	Capacity:	225-300pcs
Height:	348mm/13.70"	Operating Pressure:	70-100psi
Length:	347mm/13.66"	Air Inlet:	1/4"NPT
Width:	137mm/5.39"	Trigger:	Contact

FEATURES

- ▶ Powerful for heavy-duty applications
- ▶ Well-balanced, comfort rubber grip
- ▶ Bump firing trigger for high speed operation
- ▶ Durable driver and bumper for long life
- ▶ Accurate nose, minimize nail jam

APPLICATIONS

- ▶ Pallets
- ▶ Crates & Wood Cases

Also available:

CN80DS



CN100DS



FASTENER SPECIFICATIONS

Model:	CN70DS	CN80DS	CN100DS
Type:	Wire Collated Coil Nails	Wire Collated Coil Nails	Wire Collated Coil Nails
Length:	45-70mm(1 3/4"-2 3/4")	45-83mm(1 3/4"-3 1/4")	65-100mm(2 1/2"-4")
Shank Dia.:	2.3-2.9mm(.090"-.114")	2.5-3.1mm(.098"-.122")	2.5-3.3mm(.098"-.129")
Head Dia.:	5.7-7.0mm(.224"-.275")	6.0-7.0mm(.236"-.275")	6.2-7.2mm(.244"-.283")
Nail Pitch:	8mm(.314")	8mm(.314")	8mm(.314")
Shank Type:	Smooth, Screw & Ring	Smooth, Screw & Ring	Smooth, Screw & Ring

TOOL SPECIFICATIONS

Model:	CN70DS	CN80DS	CN100DS
Weight:	4.02kg/8.86lbs	4.34kg/9.57lbs	5.67kg/12.5lbs
Height:	318mm/12.51"	348mm/13.70"	420mm/16.53"
Length:	376mm/14.80"	347mm/13.66"	370mm/14.56"
Width:	133mm/5.23"	137mm/5.39"	159mm/6.25"
Capacity:	Wire:225-300pcs	Wire:225-300pcs	Wire:225-300pcs
Operating Pressure:	70-100psi	70-100psi	100-120psi
Air Inlet:	1/4"NPT	1/4"NPT	3/8"NPT
Trigger:	Contact	Contact	Contact

15° COIL NAIL **CN90**
3 1/2" Coil Nailer

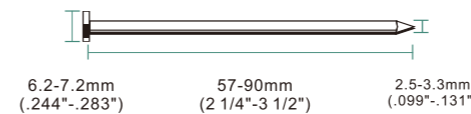

FEATURES

- ▶ Powerful for heavy-duty applications
- ▶ Rubber comfort grip
- ▶ Well-balanced, light weight
- ▶ Downward directional exhaust
- ▶ Durable driver and bumper for long life

APPLICATIONS

- ▶ Pallets
- ▶ Crates Wood Cases
- ▶ Packaging
- ▶ Decking
- ▶ Sheathing

FASTENER

Type:	Wire Collated Coil Nails
Length:	57-90mm(2 1/4"-3 1/2")
Shank Dia.:	2.5-3.3mm(.098"-.129")
Head Dia.:	6.2-7.2mm(.244"-.283")
Nail Pitch:	8mm(.314")
Shank Type:	Smooth, Screw & Ring

SIMILAR TOOLS

- ▶ Bostitch N89C
- ▶ BeA 904DC
- ▶ SENCO Pallet Pro 90

TOOL SPECIFICATIONS

Weight:	4.13kg/9.11lbs	Capacity:	225-300pcs
Height:	365mm/14.37"	Operating Pressure:	100-120psi
Length:	385mm/15.15"	Air Inlet:	3/8"NPT
Width:	137mm/5.39"	Trigger:	Contact

15°
COIL NAIL **CN100B**
4" Coil Nailer

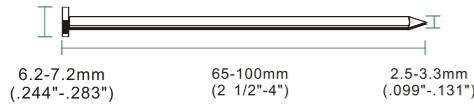

FEATURES
▶ Powerful for heavy-duty applications
▶ Well-balanced when hung on balancer
▶ Rubber comfort grip
▶ Downward directional exhaust
▶ Durable driver and bumper for long life

APPLICATIONS
▶ Pallets
▶ Crates Wood Cases
▶ Packaging
▶ Decking
▶ Sheathing

FASTENER	
Type:	Wire Collated Coil Nails
Length:	65-100mm(2 1/2"-4")
Shank Dia.:	2.5-3.3mm(.099"-.131")
Head Dia.:	6.2-7.2mm(.244"-.283")
Nail Pitch:	10.5mm(.413")
Shank Type:	Smooth, Screw & Ring

SIMILAR TOOLS
▶ SENCO Pallet Pro 100
▶ Bostitch N400C
▶ MAX CN100

TOOL SPECIFICATIONS			
Weight:	5.67kg/12.5lbs	Capacity:	225-300pcs
Height:	420mm/16.53"	Operating Pressure:	100-120psi
Length:	370mm/14.56"	Air Inlet:	3/8"NPT
Width:	159mm/6.25"	Trigger:	Contact



Premium
EPAL
Coil Nailer
For Professionals

15°
COIL NAIL **CN100**
4" Coil Nailer

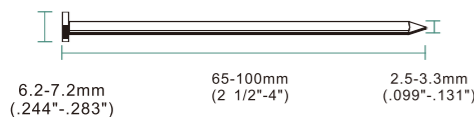

FEATURES
▶ Powerful for heavy-duty applications
▶ Well-balanced when hung on balancer
▶ Rubber comfort grip
▶ Downward directional exhaust
▶ Durable driver and bumper for long life

APPLICATIONS
▶ Pallets
▶ Crates Wood Cases
▶ Packaging
▶ Decking
▶ Sheathing

FASTENER	
Type:	Wire Collated Coil Nails
Length:	65-100mm(2 1/2"-4")
Shank Dia.:	2.5-3.3mm(.099"-.131")
Head Dia.:	6.2-7.2mm(.244"-.283")
Nail Pitch:	10.5mm(.413")
Shank Type:	Smooth, Screw & Ring

SIMILAR TOOLS
▶ SENCO Pallet Pro 100
▶ Bostitch N400C
▶ MAX CN100

TOOL SPECIFICATIONS			
Weight:	5.82kg/12.83lbs	Capacity:	225-300pcs
Height:	403mm/15.86"	Operating Pressure:	100-120psi
Length:	405mm/15.94"	Air Inlet:	3/8"NPT
Width:	143mm/5.62"	Trigger:	Contact

15°
COIL NAIL **CN100EPAL**
3 1/2" Coil Nailer

FEATURES
▶ Drives PAL Coil nails from 70-90mm
▶ Powerful for heavy-duty applications
▶ Well-balanced when hung on balancer
▶ Rubber comfort grip
▶ Downward directional exhaust
▶ Durable driver and bumper for long life

APPLICATIONS
▶ EPAL Pallets
▶ Heavy-duty pallets
▶ Packaging

FASTENER	
Type:	Wire Collated Coil Nails
Length:	70&90mm(2 3/4"&3 1/2")
Shank Dia.:	3.5mm(.138")
Head Dia.:	8.6mm(.338")
Nail Pitch:	10.5mm(.413")
Shank Type:	Smooth, Screw & Ring

SIMILAR TOOLS
▶ SENCO Pallet Pro 100
▶ Bostitch N400C
▶ MAX CN100EPAL

TOOL SPECIFICATIONS			
Weight:	5.8kg/12.79lbs	Capacity:	225-300pcs
Height:	336mm/13.22"	Operating Pressure:	100-120psi
Length:	457mm/17.99"	Air Inlet:	3/8"NPT
Width:	156mm/6.14"	Trigger:	Contact

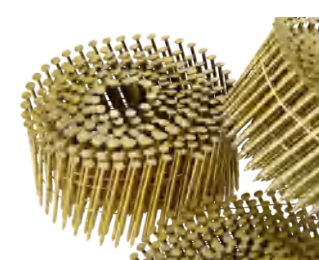
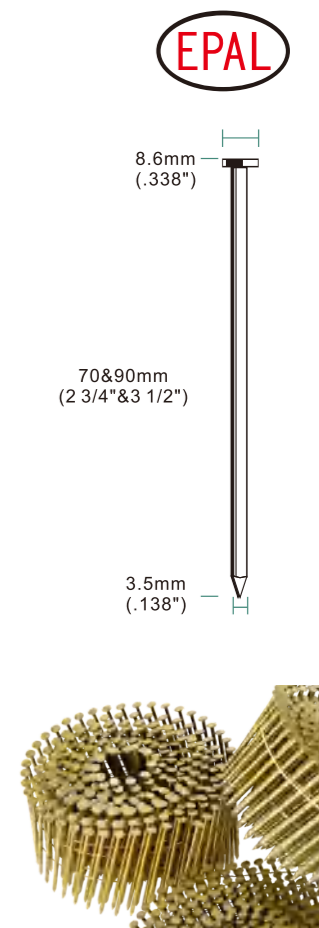

Industrial Coil Nailer



15°
COIL NAIL
CN130
5 1/8" Coil Nailer

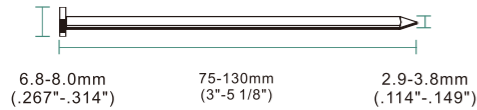

FEATURES	
▶	Powerful for heavy-duty applications
▶	Well-balanced when hung on balancer
▶	Rubber comfort grip
▶	Downward directional exhaust
▶	Durable driver and bumper for long life

APPLICATIONS	
▶	Packaging
▶	Pallets
▶	Crates & Wood Cases
▶	Framing

FASTENER	
Type:	Wire Collated Coils Nails
Length:	75-130mm(3"-5 1/8")
Shank Dia.:	2.9-3.8mm(.114"-.149")
Head Dia.:	6.8-8.0mm(.267"-.314")
Nail Pitch:	10.5mm(.413")
Shank Type:	Smooth, Screw & Ring

SIMILAR TOOLS	
▶	SENCO Pallet Pro 130

TOOL SPECIFICATIONS			
Weight:	6.51kg/14.35lbs	Capacity:	120-225pcs
Height:	479mm/18.85"	Operating Pressure:	100-120psi
Length:	370mm/14.56"	Air Inlet:	3/8"NPT
Width:	165mm/6.49"	Trigger:	Contact

Industrial Strip Nailer

21°
STRIP NAIL
SF13021
5 1/8" Strip Nailer

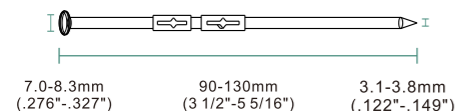

FEATURES	
▶	Powerful for heavy-duty applications
▶	Well-balanced
▶	Rubber comfort grip
▶	Durable driver and bumper for long life
▶	Second handle is included

APPLICATIONS	
▶	Packaging
▶	Pallets
▶	Crates & Wood Cases
▶	Framing

FASTENER	
Type:	Plastic Collated Strip Nails
Head Type:	Full round head
Length:	90-130mm(3 1/2"-5 5/16")
Shank Dia.:	3.1-3.8mm(.122"-.149")
Head Dia.:	7.0-8.3mm(.276"-.327")

SIMILAR TOOLS	
▶	REICH F3535

TOOL SPECIFICATIONS			
Weight:	6.76kg/14.9lbs	Capacity:	30pcs
Height:	463mm/18.22"	Operating Pressure:	100-120psi
Length:	528mm/20.78"	Air Inlet:	3/8"NPT
Width:	153mm/6.02"	Trigger:	Contact

NAIL REMOVING



**DRIVES NAILS FROM THE POINT
FOR REMOVING IN WOOD**

T50SC De-Nailer



FEATURES	APPLICATIONS
▶ Tool for pallet repairing	▶ Pallets
▶ Light weight & well-balanced	▶ Crates & Wood Cases
▶ Rubber comfort grip	▶ Packaging
▶ Durable driver and bumper for long life	

TOOL SPECIFICATIONS			
Weight:	1.06kg/2.34lbs	Capacity:	/
Height:	228mm/8.97"	Operating Pressure:	60-100psi
Length:	282mm/11.10"	Air Inlet:	1/4"NPT
Width:	62mm/2.44"	Trigger:	Trigger

NP55 De-Nailer



FEATURES	APPLICATIONS
▶ Tool for pallet repairing	▶ Pallets
▶ Light weight & well-balanced	▶ Crates & Wood Cases
▶ Rubber comfort grip	▶ Packaging
▶ Durable driver and bumper for long life	
▶ Powerful for heavy-duty applications	

TOOL SPECIFICATIONS			
Weight:	2.0kg/4.41lbs	Capacity:	/
Height:	285mm/11.22"	Operating Pressure:	60-100psi
Length:	298mm/11.73"	Air Inlet:	1/4"NPT
Width:	99mm/3.90"	Trigger:	Trigger

NP70 De-Nailer



FEATURES	APPLICATIONS
▶ Tool for pallet repairing	▶ Pallets
▶ Light weight & well-balanced	▶ Crates & Wood Cases
▶ Rubber comfort grip	▶ Packaging
▶ Durable driver and bumper for long life	
▶ Powerful for heavy-duty applications	

TOOL SPECIFICATIONS			
Weight:	2.73kg/6.02lbs	Capacity:	/
Height:	303mm/11.92"	Operating Pressure:	85-115psi
Length:	343mm/13.50"	Air Inlet:	1/4"NPT
Width:	109mm/4.29"	Trigger:	Trigger

WIRE COLLATED COIL NAILS



Coil Roofing Nails

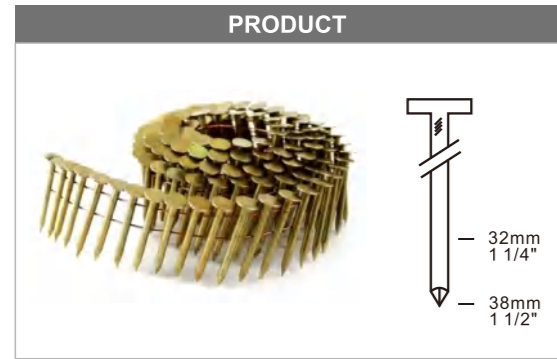

NAIL SPECIFICATIONS					
MODEL	LENGTH	DIAMETER	FINISH	PCS	BOX
32mm	1 1/4"(32mm)	.120"(3mm)	Galv.	7200	1
38mm	1 1/2"(38mm)	.120"(3mm)	Galv.	7200	1

Coil Nails



NAIL SPECIFICATIONS					
MODEL	SIZE	DIAMETER	FINISH	BOX / QTY	BOX / CTN
2125	1"(25mm)	.083"(2.1mm)	Coating	20000	1
2127	1 1/8"(27mm)	.083"(2.1mm)	Coating	20000	1
2128	1 1/8"(28mm)	.083"(2.1mm)	Coating	16000	1
2132	1 1/4"(32mm)	.083"(2.1mm)	Coating	16000	1
2135	1 3/8"(35mm)	.083"(2.1mm)	Coating	16000	1
2138	1 1/2"(38mm)	.083"(2.1mm)	Coating	16000	1
2140	1 9/16"(40mm)	.083"(2.1mm)	Coating	16000	1
2145	1 3/4"(45mm)	.083"(2.1mm)	Coating	12000	1
2150	2"(50mm)	.083"(2.1mm)	Coating	12000	1
2155	2 1/8"(55mm)	.083"(2.1mm)	Coating	12000	1
2157	2 1/4"(55mm)	.083"(2.1mm)	Coating	12000	1
2345	1 3/4"(45mm)	.091"(2.3mm)	Coating	9000	1
2350B	2"(50mm)	.091"(2.3mm)	Coating	9000	1
2355	2 1/8"(55mm)	.091"(2.3mm)	Coating	9000	1
2357B	2 1/4"(57mm)	.091"(2.3mm)	Coating	9000	1
2360	2 3/8"(60mm)	.091"(2.3mm)	Coating	9000	1
2364	2 1/2"(64mm)	.091"(2.3mm)	Coating	9000	1
2545	1 3/4"(45mm)	.098"(2.5mm)	Coating	9000	1
2550	2"(50mm)	.098"(2.5mm)	Coating	9000	1
2557	2 1/4"(57mm)	.098"(2.5mm)	Coating	9000	1
2560	2 3/8"(60mm)	.098"(2.5mm)	Coating	9000	1
2564	2 1/2"(64mm)	.098"(2.5mm)	Coating	9000	1

NAIL SPECIFICATIONS					
MODEL	SIZE	DIAMETER	FINISH	BOX / QTY	BOX / CTN
2570	2 3/4"(70mm)	.098"(2.5mm)	Coating	6000	1
2575	3"(75mm)	.098"(2.5mm)	Coating	6000	1
2580	3 1/8"(80mm)	.098"(2.5mm)	Coating	6000	1
2970	2 3/4"(70mm)	.114"(2.9mm)	Coating	4500	1
2976	3"(76mm)	.114"(2.9mm)	Coating	4500	1
2980	3 1/8"(80mm)	.114"(2.9mm)	Coating	4500	1
2990	3 1/2"(90mm)	.114"(2.9mm)	Coating	4500	1
29100	4"(100mm)	.114"(2.9mm)	Coating	2700	1
3170	2 3/4"(70mm)	.122"(3.1mm)	Coating	2700	1
3175	3"(75mm)	.122"(3.1mm)	Coating	2700	1
3180	3 1/8"(80mm)	.122"(3.1mm)	Coating	2700	1
3190	3 1/2"(90mm)	.122"(3.1mm)	Coating	2700	1
3195	3 3/4"(95mm)	.122"(3.1mm)	Coating	2700	1
31100	4"(100mm)	.122"(3.1mm)	Coating	2700	1
31110	3 1/2"(90mm)	.122"(3.1mm)	Coating	2700	1
31120	4 13/16"(120mm)	.122"(3.1mm)	Coating	2700	1
3483	3 1/4"(38mm)	.130"(3.3mm)	Coating	2700	1
3490	3 1/2"(90mm)	.130"(3.3mm)	Coating	2700	1
3495	3 3/4"(95mm)	.130"(3.3mm)	Coating	2700	1
34100	4"(100mm)	.130"(3.3mm)	Coating	2700	1
34120	4 13/16"(120mm)	.130"(3.3mm)	Coating	2700	1
38130	5 3/16"(64mm)	.156"(3.8mm)	Coating	1440	1

MATTRESS & CAR SEAT



16^{GA}
C-RING
SC760B
1/2" C-Ring Plier



STEEL
MAGAZINE

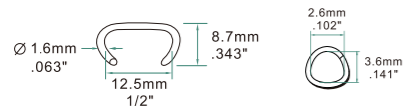

FEATURES		APPLICATIONS	
▶ Well-balanced, ergonomically designed		▶ Wire Cage	
▶ Large capacity long magazine		▶ Car Seat	
▶ Rubber comfort grip		▶ Spring Mattress	
▶ Can be easily converted to right or left hand operation		▶ Bag Closure	
FASTENER		SIMILAR TOOLS	
Type:	Tape Collated C-Ring	▶ Bostitch SC760	
Gauge Size:	16GA	▶ MEIHO MC-660	
Wire Dia.:	1.6mm(.063")		
Inner Crown:	12.5mm(1/2")		
Closure Dia:	2.6-3.6mm(.102"-.141")		
Material:	Galvanized, Aluminum, Stainless		

TOOL SPECIFICATIONS			
Weight:	1.63kg/3.59lbs	Capacity:	100pcs
Height:	201mm/7.91"	Operating Pressure:	70-100psi
Length:	330mm/12.99"	Air Inlet:	1/4"NPT
Width:	84mm/3.30"	Trigger:	Trigger

15^{GA}
C-RING
SC7C
3/4" C-Ring Plier



STEEL
MAGAZINE

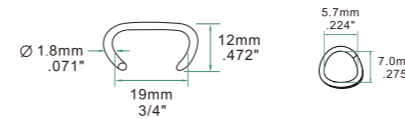

FEATURES		APPLICATIONS	
▶ Well-balanced, ergonomically designed		▶ Wire Cage	
▶ Large capacity long magazine		▶ Car Seat	
▶ Rubber comfort grip		▶ Spring Mattress	
▶ Can be easily converted to right or left hand operation		▶ Bag Closure	
FASTENER		SIMILAR TOOLS	
Type:	Tape Collated C-Ring	▶ Bostitch SC7C	
Gauge Size:	15GA	▶ MEIHO MC-6CA	
Wire Dia.:	1.8mm(.070")		
Inner Crown:	19mm(3/4")		
Closure Dia:	5.7-7.0mm(.224"-.275")		
Material:	Galvanized, Aluminum, Stainless		

TOOL SPECIFICATIONS			
Weight:	1.68kg/3.70lbs	Capacity:	100pcs
Height:	201mm/7.91"	Operating Pressure:	70-100psi
Length:	338mm/13.30"	Air Inlet:	1/4"NPT
Width:	84mm/3.30"	Trigger:	Trigger

16^{GA}
C-RING
SC760C
1/2" C-Ring Plier

NEW



STEEL
MAGAZINE

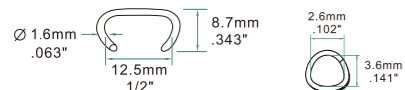

FEATURES		APPLICATIONS	
▶ Light weight		▶ Wire Cage	
▶ Well-balanced, ergonomically designed		▶ Car Seat	
▶ Large capacity long magazine		▶ Spring Mattress	
▶ Rubber comfort grip		▶ Bag Closure	
▶ Can be easily converted to right or left hand operation			
▶ Carved jaw with longer life			
FASTENER		SIMILAR TOOLS	
Type:	Tape Collated C-Ring	▶ Bostitch SC760	
Gauge Size:	16GA	▶ MEIHO MC-660	
Wire Dia.:	1.6mm(.063")		
Inner Crown:	12.5mm(1/2")		
Closure Dia:	2.6-3.6mm(.102"-.141")		
Material:	Galvanized, Aluminum, Stainless		

TOOL SPECIFICATIONS			
Weight:	1.57kg/3.46lbs	Capacity:	100pcs
Height:	201mm/7.91"	Operating Pressure:	70-100psi
Length:	300mm/11.81"	Air Inlet:	1/4"NPT
Width:	84mm/3.30"	Trigger:	Trigger

15^{GA}
C-RING
SC7C-P
3/4" C-Ring Plier

NEW



PLASTIC
MAGAZINE

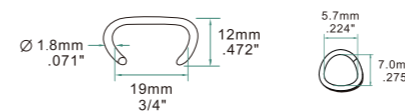

FEATURES		APPLICATIONS	
▶ Light weight, plastic magazine		▶ Wire Cage	
▶ Well-balanced, ergonomically designed		▶ Car Seat	
▶ Large capacity long magazine		▶ Spring Mattress	
▶ Rubber comfort grip		▶ Bag Closure	
▶ Can be easily converted to right or left hand operation			
FASTENER		SIMILAR TOOLS	
Type:	Tape Collated C-Ring	▶ Bostitch SC7C	
Gauge Size:	15GA	▶ MEIHO MC-6CA	
Wire Dia.:	1.8mm(.070")		
Inner Crown:	19mm(3/4")		
Closure Dia:	5.7-7.0mm(.224"-.275")		
Material:	Galvanized, Aluminum, Stainless		

TOOL SPECIFICATIONS			
Weight:	1.47kg/3.24lbs	Capacity:	100pcs
Height:	201mm/7.91"	Operating Pressure:	70-100psi
Length:	330mm/12.99"	Air Inlet:	1/4"NPT
Width:	84mm/3.30"	Trigger:	Trigger

15^{GA}
C-RING

SC7E

3/4" C-Ring Plier
Extended Nose



STEEL
MAGAZINE



FEATURES

- ▶ Well-balanced, ergonomically designed
- ▶ Large capacity long magazine
- ▶ Rubber comfort grip
- ▶ Can be easily converted to right or left hand operation

APPLICATIONS

- ▶ Wire Cage
- ▶ Car Seat
- ▶ Spring Mattress
- ▶ Bag Closure

FASTENER

Type:	Tape Collated C-Ring
Gauge Size:	15GA
Wire Dia.:	1.8mm(.070")
Inner Crown:	19mm(3/4")
Closure Dia:	8.8mm(.346")
Material:	Galvanized, Aluminum, Stainless

SIMILAR TOOLS

- ▶ BEA CL24
- ▶ Bostitch SC7E
- ▶ MEIHO MC-6LNA

TOOL SPECIFICATIONS

Weight:	1.74kg/3.84lbs	Capacity:	100pcs
Height:	201mm/7.91"	Operating Pressure:	70-100psi
Length:	349mm/13.74"	Air Inlet:	1/4"NPT
Width:	84mm/3.30"	Trigger:	Trigger

15^{GA}
C-RING

SC77XE

3/4" C-Ring Plier
Extra Extended Nose



EXTRA
NOSE



FEATURES

- ▶ Well-balanced, ergonomically designed
- ▶ Large capacity long magazine
- ▶ Rubber comfort grip
- ▶ Can be easily converted to right or left hand operation

APPLICATIONS

- ▶ Wire Cage
- ▶ Car Seat
- ▶ Spring Mattress
- ▶ Bag Closure

FASTENER

Type:	Tape Collated C-Ring
Gauge Size:	15GA
Wire Dia.:	1.8mm(.070")
Inner Crown:	19mm(3/4")
Closure Dia:	8.8mm(.346")
Material:	Galvanized, Aluminum, Stainless

SIMILAR TOOLS

- ▶ Bostitch SC77XE

TOOL SPECIFICATIONS

Weight:	1.815kg/4.0lbs	Capacity:	100pcs
Height:	216mm/8.50"	Operating Pressure:	70-100psi
Length:	375mm/14.76"	Air Inlet:	1/4"NPT
Width:	88mm/3.46"	Trigger:	Trigger

15^{GA}
C-RING

SC7E-P

3/4" C-Ring Plier
Extended Nose

NEW



PLASTIC
MAGAZINE

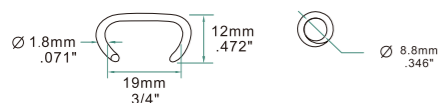

FEATURES

- ▶ Light weight, plastic magazine
- ▶ Well-balanced, ergonomically designed
- ▶ Large capacity long magazine
- ▶ Rubber comfort grip
- ▶ Can be easily converted to right or left hand operation

APPLICATIONS

- ▶ Wire Cage
- ▶ Car Seat
- ▶ Spring Mattress
- ▶ Bag Closure

FASTENER

Type:	Tape Collated C-Ring
Gauge Size:	15GA
Wire Dia.:	1.8mm(.070")
Inner Crown:	19mm(3/4")
Closure Dia:	8.8mm(.346")
Material:	Galvanized, Aluminum, Stainless

SIMILAR TOOLS

- ▶ BEA CL24
- ▶ Bostitch SC7E
- ▶ MEIHO MC-6LNA

TOOL SPECIFICATIONS

Weight:	1.53kg/3.37lbs	Capacity:	100pcs
Height:	201mm/7.91"	Operating Pressure:	70-100psi
Length:	355mm/13.97"	Air Inlet:	1/4"NPT
Width:	84mm/3.30"	Trigger:	Trigger

Reference Chart for C-Ring Plier

Model	Nose Length	Wire Diameter	Weight	Magazine Material	Capacity	Appearance
SC760B	Standard Nose	16GA	1.63KG	Steel	100PCS	
SC760C		16GA	1.57KG	Steel	100PCS	
SC7C	Standard Nose	15GA	1.68KG	Steel	100PCS	
SC7C-P		15GA	1.47KG	Plastic	100PCS	
SC7E	Extended Nose	15GA	1.74KG	Steel	100PCS	
SC7E-P		15GA	1.53KG	Plastic	100PCS	
SC77XE	Extra Extended Nose	15GA	1.815KG	Steel	100PCS	

11 GA C-RING MT-HC45 1 1/2" Manual C-Ring Plier

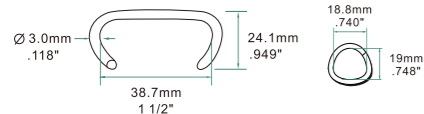

FEATURES	APPLICATIONS
▶ Well-balanced, ergonomically designed	▶ Gabion
▶ Convenient to use, no compressed air is needed	▶ Wire Cage
▶ Rubber comfort grip	▶ Fencing

FASTENER	SIMILAR TOOLS
Type: Tape Collated C-Ring	▶ Bostitch HFP9
Gauge Size: 11GA	
Wire Dia.: 3mm(.118")	
Inner Crown: 38.7mm(1 1/2")	
Closure Dia: 18.8-19mm(.740"-.748")	
Material: Galvanized, Aluminum, Stainless	

TOOL SPECIFICATIONS			
Weight:	4.31kg/9.50lbs	Capacity:	45pcs
Height:	165mm/6.49"	Operating Pressure:	/
Length:	673mm/26.49"	Air Inlet:	/
Width:	125mm/4.92"	Trigger:	Manual

M66L Clipper



- APPLICATIONS**
- ▶ Wire Cage
 - ▶ Spring Mattress
 - ▶ Car Seat



40% lighter than traditional models

CLIPS SPECIFICATIONS					
Model	Crown	Height	Width	Thickness	Type
CL-3	6.2mm	12.3mm	22mm	0.8mm	Strip
CL-4	6.2mm	14.1mm	22mm	0.8mm	Strip
CL-5	6.2mm	15.5mm	19mm	0.8mm	Strip
CL-71	6.2mm	12.3mm	19mm	0.8mm	Strip
CL-72	6.2mm	14.1mm	19mm	0.8mm	Strip

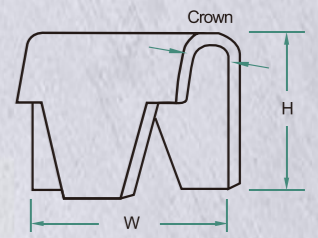

Industrial Stapling Plier

20 GA FINE WIRE STAPLE P88U 1/2" Crown Stapling Plier

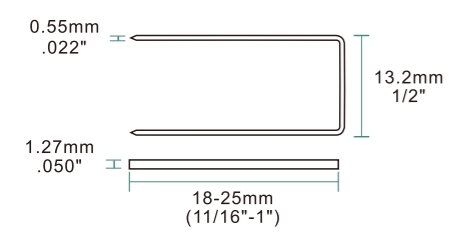

FEATURES	APPLICATIONS
▶ High-speed operation	▶ Spring Bedding
▶ Detachable magazine for quick jam clearing	▶ Furniture
▶ Second safety trigger	
▶ Rubber comfort grip	

FASTENER	SIMILAR TOOLS
Type: 88 Series Staples	▶ Bostitch P88-SJ-E
Crown: 13.2mm(.519")	▶ Omer P88SJ
Width: 1.27(.050")	
Thickness: 0.55mm(.022")	
Length: 18-25mm(3/4"-1")	
Collation Type: Glued Strip	

TOOL SPECIFICATIONS			
Weight:	2.18kg/4.81lbs	Capacity:	200pcs
Height:	303mm/11.92"	Operating Pressure:	70-100psi
Length:	362mm/14.25"	Air Inlet:	1/4"NPT
Width:	80mm/3.14"	Trigger:	Trigger

TOOL SPECIFICATIONS			
Weight:	2.25kg/4.96lbs	Capacity:	37pcs
Height:	173mm/6.81"	Operating Pressure:	85-115psi
Length:	426mm/16.77"	Air Inlet:	1/4"NPT
Width:	102mm/4.01"	Trigger:	Trigger



M66B / M65B / M46B / M45B

Clipper



FEATURES

- ▶ Well-balanced, ergonomically designed
- ▶ Powerful motor for high speed operation
- ▶ Durable blade and anvil for long life
- ▶ Low maintenance

APPLICATIONS

- ▶ Wire Cage
- ▶ Spring Mattress
- ▶ Car Seat

SIMILAR TOOLS

- ▶ Bostitch HR-45
- ▶ Vertex Pro Clinch 45

CLIPS SPECIFICATIONS

Tool	Model	Crown	Height	Width	Thickness	Type
M66B	CL-3	6.2mm	12.3mm	22mm	0.8mm	Strip
	CL-4	6.2mm	14.1mm	22mm	0.8mm	Strip
	CL-5	6.2mm	15.5mm	19mm	0.8mm	Strip
	CL-71	6.2mm	12.3mm	19mm	0.8mm	Strip
	CL-72	6.2mm	14.1mm	19mm	0.8mm	Strip
M65B	CL-23	4.8mm	12.7mm	22mm	0.8mm	Strip
	CL-24	4.8mm	15.5mm	22mm	0.8mm	Strip
	CL-73	4.8mm	12.7mm	19mm	0.8mm	Strip
	CL-74	4.8mm	15.5mm	19mm	0.8mm	Strip
M46B	CL-12	6.2mm	11.0mm	11mm	0.8mm	Strip
	CL-14	6.2mm	12.7mm	11mm	0.8mm	Strip
	CL-16	6.2mm	15.0mm	11mm	0.8mm	Strip
M45B	CL-18	6.2mm	13.3mm	11mm	0.8mm	Strip
	CL-13	4.8mm	10.7mm	11mm	0.8mm	Strip
	CL-15	4.8mm	9.9mm	11mm	0.8mm	Strip
	CL-17	4.8mm	10.0mm	11mm	0.8mm	Strip

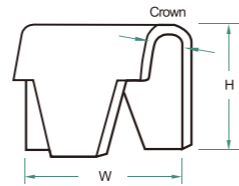

TOOL SPECIFICATIONS

Model:	M66B	M65B	M46B	M45B
Weight:	3.21kg/7.08lbs	3.1kg/6.83lbs	3.0kg/6.61lbs	3.01kg/6.64lbs
Height:	200mm/7.87"	200mm/7.87"	200mm/7.87"	200mm/7.87"
Length:	450mm/17.71"	450mm/17.71"	450mm/17.71"	450mm/17.71"
Width:	95mm/3.74"	95mm/3.74"	95mm/3.74"	95mm/3.74"
Capacity:	37pcs	45pcs	37pcs	45pcs
Operating Pressure:	85-115psi	85-115psi	85-115psi	85-115psi
Air Inlet:	1/4"NPT	1/4"NPT	1/4"NPT	1/4"NPT
Trigger:	Trigger	Trigger	Trigger	Trigger

C-RINGS & CLIPS SERIES



15^{GA}
C-RING

16^{GA}
C-RING

C-Ring Series

PRODUCT



C-RING SPECIFICATIONS

MODEL	A	B	C	D	PCS	BOX
SC7	.071"(1.8mm)	3/4"(19mm)	.472"(12mm)	.189"-.315"(4.8-8mm)	10000	4
SC760	.063"(1.6mm)	1/2"(12.5mm)	.343"(8.7mm)	.126"-.189"(3.2-4.8mm)	18000	4
C56	.079"(2.0mm)	1 1/2"(39mm)	3/4"(20mm)	.590"-.709"(15-18mm)	10000	1
C60	.079"(2.0mm)	2 1/4"(56mm)	3/4"(20mm)	.787"-.984"(20-25mm)	10000	1

Clips Series

PRODUCT

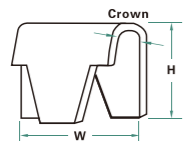
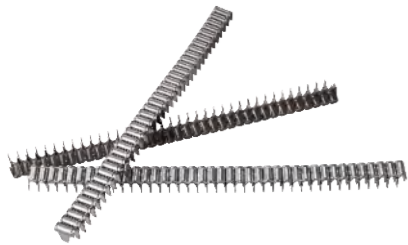

CLIPS SPECIFICATIONS

Tool	Model	Crown	Height	Width	Thickness	Type
M66B	CL-3	6.2mm	12.3mm	22mm	0.8mm	Strip
	CL-4	6.2mm	14.1mm	22mm	0.8mm	Strip
	CL-5	6.2mm	15.5mm	19mm	0.8mm	Strip
	CL-71	6.2mm	12.3mm	19mm	0.8mm	Strip
	CL-72	6.2mm	14.1mm	19mm	0.8mm	Strip
M65B	CL-23	4.8mm	12.7mm	22mm	0.8mm	Strip
	CL-24	4.8mm	15.5mm	22mm	0.8mm	Strip
	CL-73	4.8mm	12.7mm	19mm	0.8mm	Strip
	CL-74	4.8mm	15.5mm	19mm	0.8mm	Strip
M46B	CL-12	6.2mm	11.0mm	11mm	0.8mm	Strip
	CL-14	6.2mm	12.7mm	11mm	0.8mm	Strip
	CL-16	6.2mm	15.0mm	11mm	0.8mm	Strip
	CL-18	6.2mm	13.3mm	11mm	0.8mm	Strip
M45B	CL-13	4.8mm	10.7mm	11mm	0.8mm	Strip
	CL-15	4.8mm	9.9mm	11mm	0.8mm	Strip
	CL-17	4.8mm	10.0mm	11mm	0.8mm	Strip

88 Series

PRODUCT

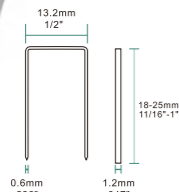
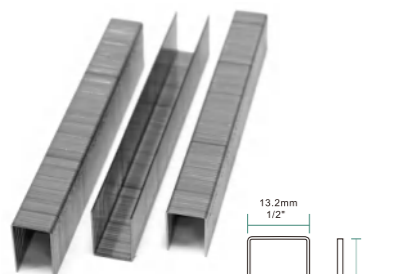

STAPLE SPECIFICATIONS

MODEL	SIZE	FINISH	BOX / QTY	BOX / CTN
1218J	5/8"(18mm)	Galv	3000	20
1220J	3/4"(20mm)	Galv	3000	20
1222J	8/8"(22mm)	Galv	3000	20

FINISH & WOODWORKING



23^{GA}
HEADLESS PIN

MP622 7/8" Headless Pinner

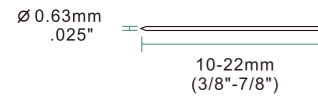

FEATURES	
▶ Well-balanced, ergonomically designed	
▶ Powerful for heavy-duty applications	
▶ Rear exhaust with embedded silencer	
▶ Secondary trigger design	
▶ Automatic adjustment magazine	

APPLICATIONS	
▶ Windows & Door	
▶ Cabinets	
▶ Interior Decoration	

FASTENER	
Type:	Glued Strip Headless Pins
Gauge Size:	23GA
Wire Dia.:	0.63mm(.024")
Length:	10-22mm(3/8"-7/8")
Material:	Galvanized, Stainless

SIMILAR TOOLS	

TOOL SPECIFICATIONS			
Weight:	0.82kg/1.81lbs	Capacity:	100pcs
Height:	166mm/6.53"	Operating Pressure:	70-100psi
Length:	230mm/9.05"	Air Inlet:	1/4"NPT
Width:	51mm/2"	Trigger:	Trigger

23^{GA}
HEADLESS PIN

MP630 1 3/16" Headless Pinner

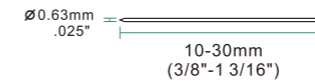

FEATURES	
▶ Well-balanced, ergonomically designed	
▶ Powerful for heavy-duty applications	
▶ Rear exhaust with embedded silencer	
▶ Secondary trigger design	
▶ Automatic adjustment magazine	

APPLICATIONS	
▶ Windows & Door	
▶ Cabinets	
▶ Interior Decoration	

FASTENER	
Type:	Glued Strip Headless Pins
Gauge Size:	23GA
Wire Dia.:	0.63mm(.024")
Length:	10-30mm(3/8"-1 3/16")
Material:	Galvanized, Stainless

SIMILAR TOOLS	
▶ GREX P630	
▶ Bostitch HP 118K	

TOOL SPECIFICATIONS			
Weight:	0.90kg/1.98lbs	Capacity:	100pcs
Height:	182mm/7.16"	Operating Pressure:	70-100psi
Length:	230mm/9.05"	Air Inlet:	1/4"NPT
Width:	51mm/2"	Trigger:	Trigger

23^{GA}
HEADLESS PIN

P630C 1 3/16" Headless Pinner

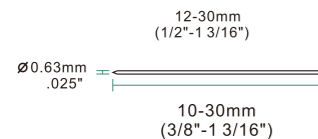

FEATURES	
▶ Well-balanced, ergonomically designed	
▶ Powerful for heavy-duty applications	

APPLICATIONS	
▶ Windows & Door	
▶ Cabinets	
▶ Interior Decoration	

FASTENER	
Type:	Glued Strip Headless Pins
Gauge Size:	23GA
Wire Dia.:	0.63mm(.024")
Length:	10-30mm(3/8"-1 3/16")
Material:	Galvanized, Stainless

SIMILAR TOOLS	

TOOL SPECIFICATIONS			
Weight:	0.92kg/2.03lbs	Capacity:	150pcs
Height:	178mm/7"	Operating Pressure:	70-100psi
Length:	215mm/8.46"	Air Inlet:	1/4"NPT
Width:	42mm/1.65"	Trigger:	Trigger

23^{GA}
HEADLESS PIN

MP635 1 3/8" Headless Pinner

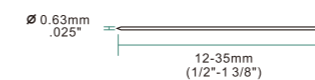

FEATURES	
▶ Well-balanced, ergonomically designed	
▶ Powerful for heavy-duty applications	
▶ Rear exhaust with embedded silencer	
▶ Secondary trigger design	
▶ Automatic adjustment magazine	

APPLICATIONS	
▶ Windows & Door	
▶ Cabinets	
▶ Interior Decoration	

FASTENER	
Type:	Glued Strip Headless Pins
Gauge Size:	23GA
Wire Dia.:	0.63mm(.024")
Length:	12-35mm(1/2"-1 3/8")
Material:	Galvanized, Stainless

SIMILAR TOOLS	
▶ MAX NF235A/23-35	
▶ SENCO FIP23SXP	
▶ GREX P635	
▶ Cadex V1/23.35	

TOOL SPECIFICATIONS			
Weight:	1.1kg/2.43lbs	Capacity:	100pcs
Height:	194mm/7.63"	Operating Pressure:	70-100psi
Length:	230mm/9.05"	Air Inlet:	1/4"NPT
Width:	60mm/2.36"	Trigger:	Trigger

23
GA
HEADLESS PIN

MP650B

2" Headless / Mini Brad Pinner

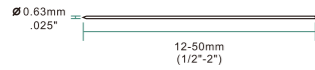

FEATURES	APPLICATIONS
▶ Well-balanced, ergonomically designed	▶ Windows & Door
▶ Powerful for heavy-duty applications	▶ Cabinets
▶ Rear exhaust with embedded silencer	▶ Interior Decoration
▶ Secondary trigger design	
▶ Automatic adjustment magazine	

FASTENER	SIMILAR TOOLS
Type: Glued Strip Headless Pins	▶ SENCO Finish Pro 23LXP
Gauge Size: 23GA	▶ GREX P650
Wire Dia.: 0.63mm(.024")	▶ Cadex CPB23.50
Length: 12-50mm(1/2"-2")	
Material: Galvanized, Stainless	

TOOL SPECIFICATIONS			
Weight:	1.15kg/2.54lbs	Capacity:	100pcs
Height:	226mm/8.89"	Operating Pressure:	80-100psi
Length:	230mm/9.05"	Air Inlet:	1/4"NPT
Width:	60mm/2.36"	Trigger:	Trigger

Premium 21 GA Headless & Mini Brad Pinner For Professionals



Perfect in details

21
GA
HEADLESS PIN

MT840

1 9/16" Headless / Mini Brad Pinner

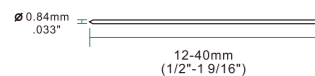

FEATURES	APPLICATIONS
▶ Well-balanced, ergonomically designed	▶ Windows & Door
▶ Powerful for heavy-duty applications	▶ Cabinets
▶ Rear exhaust with embedded silencer	▶ Interior Decoration
▶ Secondary trigger design	
▶ Automatic adjustment magazine	

FASTENER	SIMILAR TOOLS
Type: Glued Strip Headless Pins	▶ Omer MG40
Gauge Size: 21GA	▶ Bostitch MB2140
Wire Dia.: 0.84mm(.033")	
Length: 12-40mm(1/2"-1 9/16")	
Material: Galvanized, Stainless	

TOOL SPECIFICATIONS			
Weight:	1.19kg/2.62lbs	Capacity:	147pcs
Height:	208mm/8.18"	Operating Pressure:	80-100psi
Length:		Air Inlet:	1/4"NPT
Width:	60mm/2.36"	Trigger:	Trigger

21
GA
HEADLESS PIN

MT850

2" Headless / Mini Brad Pinner

FEATURES	APPLICATIONS
▶ Well-balanced, ergonomically designed	▶ Windows & Door
▶ Powerful for heavy-duty applications	▶ Cabinets
▶ Rear exhaust with embedded silencer	▶ Interior Decoration
▶ Secondary trigger design	
▶ Automatic adjustment magazine	

FASTENER	SIMILAR TOOLS
Type: Glued Strip Headless Pins	▶ SENCO Finish Pro 21LXP
Gauge Size: 21GA	▶ Omer MG40
Wire Dia.: 0.84mm(.033")	▶ Cadex CPB21.50
Length: 12-50mm(1/2"-2")	
Material: Galvanized, Stainless	

TOOL SPECIFICATIONS			
Weight:	1.3kg/2.87lbs	Capacity:	147pcs
Height:	227mm/8.93"	Operating Pressure:	80-100psi
Length:	256mm/10.07"	Air Inlet:	1/4"NPT
Width:	60mm/2.36"	Trigger:	Trigger

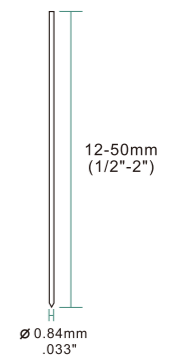

23 GA
HEADLESS PIN

Headless Pins Series

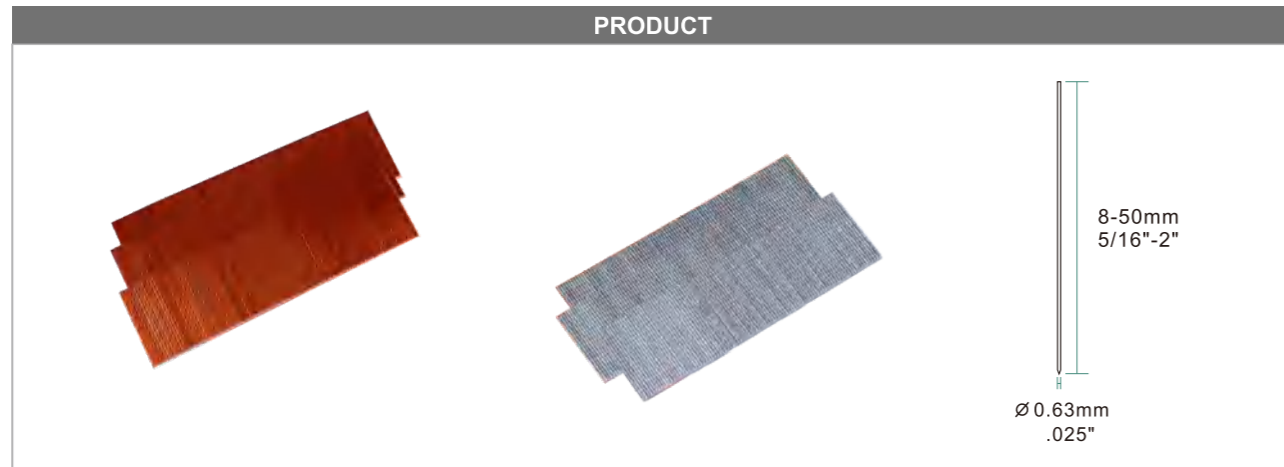

PINS SPECIFICATIONS				
MODEL	SIZE	FINISH	BOX / QTY	BOX / CTN
608	5/16"(8mm)	Copper Coating / Stainless	10000	48
610	3/8"(10mm)	Copper Coating / Stainless	10000	48
612	1/2"(12mm)	Copper Coating / Stainless	10000	48
615	5/8"(15mm)	Copper Coating / Stainless	10000	48
618	3/4"(18mm)	Copper Coating / Stainless	10000	48
620	13/16"(20mm)	Copper Coating / Stainless	10000	48
622	7/8"(22mm)	Copper Coating / Stainless	10000	48
625	1"(25mm)	Copper Coating / Stainless	10000	48
630	1 3/16"(30mm)	Copper Coating / Stainless	10000	48
635	1 3/8"(35mm)	Copper Coating / Stainless	10000	24/48
640	1 9/16"(40mm)	Copper Coating / Stainless	10000	48
645	1 3/4"(45mm)	Copper Coating / Stainless	10000	48
650	2"(50mm)	Copper Coating / Stainless	10000	48



FURNITURE & UPHOLSTERY



22 GA
FINE WIRE
STAPLE

21 GA
FINE WIRE
STAPLE

20 GA
FINE WIRE
STAPLE

MT7116 / MT8016 / MT5016

Fine Wire Stapler / Standard



FEATURES

- ▶ Compact and light weight design
- ▶ Built in silencer makes soft noise
- ▶ Rear exhaust keeps oil off fabric and face
- ▶ Ergonomic handle with rubber comfort grip
- ▶ Durable driver and bumper for long life

APPLICATIONS

- ▶ Upholstery
- ▶ Furniture
- ▶ Cabinets
- ▶ Car Seat
- ▶ Picture Frames

FASTENER SPECIFICATIONS

Model:	MT7116	MT8016	MT5016
Type:	22GA Fine Wire Staples	21GA Fine Wire Staples	20GA Fine Wire Staples
Length:	6-16mm(1/4"-5/8")	6-16mm(1/4"-5/8")	6-16mm(1/4"-5/8")
Width:	0.75mm(.029")	0.95mm(.037")	1.27mm(.050")
Thickness:	0.60mm(.023")	0.65mm(.025")	0.53mm(.020")
Crown:	9.0mm(3/8")	12.8mm(1/2")	12.6mm(1/2")
Collation Type:	Glued Strip	Glued Strip	Glued Strip

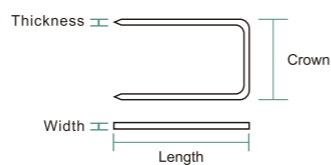

TOOL SPECIFICATIONS

Model:	MT7116	MT8016	MT5016
Weight:	0.94kg/2.07lbs	0.94kg/2.07lbs	0.94kg/2.07lbs
Height:	105mm/4.13"	105mm/4.13"	105mm/4.13"
Length:	213mm/8.38"	213mm/8.38"	213mm/8.38"
Width:	44mm/1.73"	44mm/1.73"	44mm/1.73"
Capacity:	190pcs	150pcs	114pcs
Operating Pressure:	70-100psi	70-100psi	70-100psi
Air Inlet:	1/4"NPT	1/4"NPT	1/4"NPT
Trigger:	Trigger	Trigger	Trigger

22 GA
FINE WIRE
STAPLE

21 GA
FINE WIRE
STAPLE

20 GA
FINE WIRE
STAPLE

MT7116S / MT8016S / MT5016S

Fine Wire Stapler / Secondary Trigger



FEATURES

- ▶ Compact and light weight design
- ▶ Built in silencer makes soft noise
- ▶ Rear exhaust keeps oil off fabric and face
- ▶ Ergonomic handle with rubber comfort grip
- ▶ Durable driver and bumper for long life

APPLICATIONS

- ▶ Upholstery
- ▶ Furniture
- ▶ Cabinets
- ▶ Car Seat
- ▶ Picture Frames

FASTENER SPECIFICATIONS

Model:	MT7116S	MT8016S	MT5016S
Type:	22GA Fine Wire Staples	21GA Fine Wire Staples	20GA Fine Wire Staples
Length:	6-16mm(1/4"-5/8")	6-16mm(1/4"-5/8")	6-16mm(1/4"-5/8")
Width:	0.75mm(.029")	0.95mm(.037")	1.27mm(.050")
Thickness:	0.60mm(.023")	0.65mm(.025")	0.53mm(.020")
Crown:	9.0mm(3/8")	12.8mm(1/2")	12.6mm(1/2")
Collation Type:	Glued Strip	Glued Strip	Glued Strip

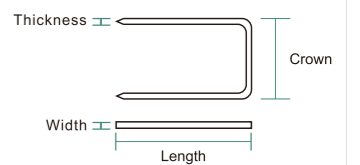

TOOL SPECIFICATIONS

Model:	MT7116S	MT8016S	MT5016S
Weight:	0.95kg/2.09lbs	0.95kg/2.09lbs	0.95kg/2.09lbs
Height:	105mm/4.13"	105mm/4.13"	105mm/4.13"
Length:	213mm/8.38"	213mm/8.38"	213mm/8.38"
Width:	44mm/1.73"	44mm/1.73"	44mm/1.73"
Capacity:	190pcs	150pcs	114pcs
Operating Pressure:	70-100psi	70-100psi	70-100psi
Air Inlet:	1/4"NPT	1/4"NPT	1/4"NPT
Trigger:	Trigger	Trigger	Trigger

22 GA
FINE WIRE
STAPLE

MT7116LN / MT8016LN / MT5016SLN

Fine Wire Stapler / Long Nose

21 GA
FINE WIRE
STAPLE

20 GA
FINE WIRE
STAPLE



Long nose

FEATURES

- ▶ Compact and light weight design
- ▶ Built in silencer makes soft noise
- ▶ Rear exhaust keeps oil off fabric and face
- ▶ Ergonomic handle with rubber comfort grip
- ▶ Durable driver and bumper for long life

APPLICATIONS

- ▶ Upholstery
- ▶ Furniture
- ▶ Cabinets
- ▶ Car Seat
- ▶ Picture Frames

FASTENER SPECIFICATIONS

Model:	MT7116LN	MT8016LN	MT5016SLN
Type:	22GA Fine Wire Staples	21GA Fine Wire Staples	20GA Fine Wire Staples
Length:	6-16mm(1/4"-5/8")	6-16mm(1/4"-5/8")	6-16mm(1/4"-5/8")
Width:	0.75mm(.029")	0.95mm(.037")	1.27mm(.050")
Thickness:	0.60mm(.023")	0.65mm(.025")	0.53mm(.020")
Crown:	9.0mm(3/8")	12.8mm(1/2")	12.6mm(1/2")
Collation Type:	Glued Strip	Glued Strip	Glued Strip

TOOL SPECIFICATIONS

Model:	MT7116LN	MT8016LN	MT5016SLN
Weight:	1.03kg/2.27lbs	1.03kg/2.27lbs	1.03kg/2.27lbs
Height:	192mm/7.55"	192mm/7.55"	192mm/7.55"
Length:	221mm/8.70"	221mm/8.70"	221mm/8.70"
Width:	43mm/1.69"	43mm/1.69"	43mm/1.69"
Capacity:	190pcs	150pcs	114pcs
Operating Pressure:	70-100psi	70-100psi	70-100psi
Air Inlet:	1/4"NPT	1/4"NPT	1/4"NPT
Trigger:	Trigger	Trigger	Trigger

21 GA
FINE WIRE
STAPLE

MTP8016 / MTP5016

Fine Wire Stapling Plier

20 GA
FINE WIRE
STAPLE



FEATURES

- ▶ Built in silencer
- ▶ Rear exhaust
- ▶ Rubber comfort grip

APPLICATIONS

- ▶ Furniture
- ▶ Cabinets
- ▶ Car Seat
- ▶ Picture Frame
- ▶ Bedding

FASTENER SPECIFICATIONS

Model:	MTP8016	MTP5016
Type:	21GA Fine Wire Staples	20GA Fine Wire Staples
Length:	6-16mm(1/4"-5/8")	6-16mm(1/4"-5/8")
Width:	0.95mm(.037")	1.27mm(.050")
Thickness:	0.65mm(.025")	0.53mm(.020")
Crown:	12.8mm(1/2")	12.6mm(1/2")
Collation Type:	Glued Strip	Glued Strip

TOOL SPECIFICATIONS

Model:	MTP8016	MTP5016
Weight:	1.5kg/3.31lbs	1.5kg/3.31lbs
Height:	230mm/9.05"	230mm/9.05"
Length:	225mm/8.85"	225mm/8.85"
Width:	60mm/2.36"	60mm/2.36"
Capacity:	125pcs	125pcs
Operating Pressure:	70-100psi	70-100psi
Air Inlet:	1/4"NPT	1/4"NPT
Trigger:	Trigger	Trigger

22 GA
FINE WIRE
STAPLE

7116 / 8016D / 1416

Fine Wire Stapler / Rear Trigger

21 GA
FINE WIRE
STAPLE



FEATURES

- ▶ Compact and light weight design
- ▶ Built in silencer makes soft noise
- ▶ Rear exhaust keeps oil off fabric and face
- ▶ Ergonomic handle with rubber comfort grip
- ▶ Durable driver and bumper for long life
- ▶ One hand magazine opening

APPLICATIONS

- ▶ Upholstery
- ▶ Furniture
- ▶ Cabinets
- ▶ Car Seat
- ▶ Picture Frames

FASTENER SPECIFICATIONS

Model:	7116	8016D	1416
Type:	22GA Fine Wire Staples	21GA Fine Wire Staples	22GA Fine Wire Staples
Length:	6-16mm(1/4"-5/8")	6-16mm(1/4"-5/8")	6-16mm(1/4"-5/8")
Width:	0.75mm(.029")	0.95mm(.037")	0.75mm(.029")
Thickness:	0.60mm(.023")	0.65mm(.025")	0.55mm(.021")
Crown:	9.0mm(3/8")	12.8mm(1/2")	9.93mm(3/8")
Collation Type:	Glued Strip	Glued Strip	Glued Strip

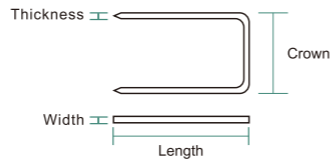

TOOL SPECIFICATIONS

Model:	7116	8016D	1416
Weight:	0.94kg/2.07lbs	0.94kg/2.07lbs	0.94kg/2.07lbs
Height:	152mm/5.98"	152mm/5.98"	145mm/5.70"
Length:	240mm/9.44"	240mm/9.44"	208mm/8.18"
Width:	40mm/1.57"	40mm/1.57"	50mm/1.96"
Capacity:	190pcs	150pcs	190pcs
Operating Pressure:	70-100psi	70-100psi	70-100psi
Air Inlet:	1/4"NPT	1/4"NPT	1/4"NPT
Trigger:	Trigger	Trigger	Trigger

22 GA
FINE WIRE
STAPLE

7116C / 8016F

Fine Wire Stapler / Rear Trigger

21 GA
FINE WIRE
STAPLE



FEATURES

- ▶ Compact and light weight design
- ▶ Built in silencer makes soft noise
- ▶ Rear exhaust keeps oil off fabric and face
- ▶ Ergonomic handle with rubber comfort grip
- ▶ Durable driver and bumper for long life
- ▶ One hand magazine opening

APPLICATIONS

- ▶ Upholstery
- ▶ Furniture
- ▶ Cabinets
- ▶ Car Seat
- ▶ Picture Frames

FASTENER SPECIFICATIONS

Model:	7116C	8016F
Type:	22GA Fine Wire Staples	20GA Fine Wire Staples
Length:	6-16mm(1/4"-5/8")	6-16mm(1/4"-5/8")
Width:	0.75mm(.029")	0.95mm(.037")
Thickness:	0.60mm(.023")	0.65mm(.025")
Crown:	9.0mm(3/8")	12.8mm(1/2")
Collation Type:	Glued Strip	Glued Strip

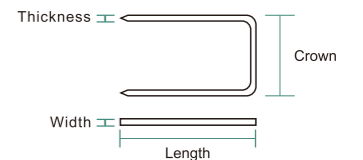

TOOL SPECIFICATIONS

Model:	7116C	8016F
Weight:	0.93kg/2.05lbs	0.94kg/2.07lbs
Height:	151mm/5.94"	151mm/5.94"
Length:	220mm/8.66"	220mm/8.66"
Width:	39mm/1.53"	39mm/1.53"
Capacity:	179pcs	150pcs
Operating Pressure:	70-100psi	70-100psi
Air Inlet:	1/4"NPT	1/4"NPT
Trigger:	Trigger	Trigger

22 GA
FINE WIRE
STAPLE

7116B / 8016B / 1416B

Fine Wire Stapler

21 GA
FINE WIRE
STAPLE



FEATURES

- ▶ Compact and light weight design
- ▶ Ergonomic handle with rubber comfort grip
- ▶ Durable driver and bumper for long life

APPLICATIONS

- ▶ Upholstery
- ▶ Furniture
- ▶ Cabinets
- ▶ Car Seat
- ▶ Picture Frames

20 GA
FINE WIRE
STAPLE

422J / 1022J

Fine Wire Stapler



FEATURES

- ▶ Compact and light weight design
- ▶ Ergonomic handle with rubber comfort grip
- ▶ Durable driver and bumper for long life

APPLICATIONS

- ▶ Upholstery
- ▶ Furniture
- ▶ Cabinets
- ▶ Car Seat
- ▶ Picture Frames

FASTENER SPECIFICATIONS

Model:	7116B	8016B	1416B
Type:	22GA Fine Wire Staples	21GA Fine Wire Staples	22GA Fine Wire Staples
Length:	6-16mm(1/4"-5/8")	6-16mm(1/4"-5/8")	6-16mm(1/4"-5/8")
Width:	0.75mm(.029")	0.95mm(.037")	0.75mm(.029")
Thickness:	0.60mm(.023")	0.65mm(.025")	0.55mm(.021")
Crown:	9.0mm(3/8")	12.8mm(1/2")	9.93mm(3/8")
Collation Type:	Glued Strip	Glued Strip	Glued Strip

FASTENER SPECIFICATIONS

Model:	422J	1022J
Type:	20GA Fine Wire Staples	20GA Fine Wire Staples
Length:	6-25mm(1/4"-1")	10-25mm(3/8"-1")
Width:	1.20mm(.047")	1.20mm(.047")
Thickness:	0.60mm(.023")	0.60mm(.023")
Crown:	5.2mm(1/4")	11.2mm(7/16")
Collation Type:	Glued Strip	Glued Strip

TOOL SPECIFICATIONS

Model:	7116B	8016B	1416B
Weight:	0.95kg/2.09lbs	0.95kg/2.09lbs	0.95kg/2.09lbs
Height:	145mm/5.70"	145mm/5.70"	145mm/5.70"
Length:	207mm/8.14"	207mm/8.14"	207mm/8.14"
Width:	50mm/1.96"	50mm/1.96"	50mm/1.96"
Capacity:	190pcs	150pcs	190pcs
Operating Pressure:	70-100psi	70-100psi	70-100psi
Air Inlet:	1/4"NPT	1/4"NPT	1/4"NPT
Trigger:	Trigger	Trigger	Trigger

TOOL SPECIFICATIONS

Model:	422J	1022J
Weight:	1.17kg/2.58lbs	1.3kg/2.87lbs
Height:	168mm/6.61"	168mm/6.61"
Length:	240mm/9.44"	240mm/9.44"
Width:	58mm/2.28"	55mm/2.16"
Capacity:	100pcs	100pcs
Operating Pressure:	70-100psi	70-100psi
Air Inlet:	1/4"NPT	1/4"NPT
Trigger:	Trigger	Trigger

20^{GA}
FINE WIRE
STAPLE

MT425J / MT1025J
Fine Wire Stapler



FEATURES

- ▶ 360° exhaust deflector
- ▶ Rubber comfort grip
- ▶ Powerful
- ▶ Light weight

APPLICATIONS

- ▶ Cabinets
- ▶ Furniture
- ▶ Windows & Door

FASTENER SPECIFICATIONS

Model:	MT425J	MT1025J
Type:	20GA Fine Wire Staples	20GA Fine Wire Staples
Length:	10-25mm(3/8"-1")	10-25mm(3/8"-1")
Width:	1.20mm(.047")	1.20mm(.047")
Thickness:	0.60mm(.023")	0.60mm(.023")
Crown:	5.2mm(1/4")	11.2mm(7/16")
Collation Type:	Glued Strip	Glued Strip

Thickness

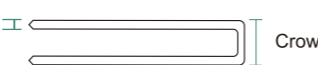

Crown

Width

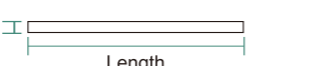

Length

TOOL SPECIFICATIONS

Model:	MT425J	MT1025J
Weight:	1.17kg/2.58lbs	1.17kg/2.58lbs
Height:	168mm/6.61"	168mm/6.61"
Length:	240mm/9.44"	240mm/9.44"
Width:	58mm/2.28"	58mm/2.28"
Capacity:	100pcs	100pcs
Operating Pressure:	70-100psi	70-100psi
Air Inlet:	1/4"NPT	1/4"NPT
Trigger:	Trigger	Trigger

18^{GA}
MEDIUM WIRE
STAPLE

MT432KLM / MT440KLM
Medium Wire Stapler



FEATURES

- ▶ Built in silencer
- ▶ Light weight
- ▶ Rubber comfort grip
- ▶ Single and rapid firing switchable mechanism
- ▶ Adjustable depth control (MT440KLM)

APPLICATIONS

- ▶ Furniture
- ▶ Cabinets
- ▶ Windows & Door

FASTENER SPECIFICATIONS

Model:	MT432KLM	MT440KLM
Type:	18GA Medium Wire Staples	18GA Medium Wire Staples
Length:	16-32mm(5/8"-1 1/4")	16-40mm(5/8"-1 5/8")
Width:	1.27mm(.050")	1.27mm(.050")
Thickness:	1.05mm(.041")	1.05mm(.041")
Crown:	5.85mm(1/4")	5.85mm(1/4")
Collation Type:	Glued Strip	Glued Strip

Thickness



Crown

Width

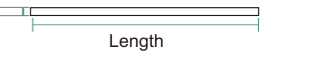

Length

TOOL SPECIFICATIONS

Model:	MT432KLM	MT440KLM
Weight:	1.45kg/3.2lbs	1.97kg/4.34lbs
Height:	220mm/8.66"	242mm/9.52"
Length:	300mm/11.81"	300mm/11.81"
Width:	60mm/2.36"	70mm/2.75"
Capacity:	140pcs	140pcs
Operating Pressure:	80-120psi	80-120psi
Air Inlet:	1/4"NPT	1/4"NPT
Trigger:	Contact	Contact

18 GA
MEDIUM WIRE
STAPLE

440KB / 9240B / 635TR

Medium Wire Stapler

16 GA
HEAVY WIRE
STAPLE



FEATURES

- ▶ Powerful
- ▶ Rubber comfort grip
- ▶ Well-balanced
- ▶ Rear exhaust
- ▶ Light weight
- ▶ Rapid firing

APPLICATIONS

- ▶ Furniture
- ▶ Cabinets
- ▶ Windows & Door

FASTENER SPECIFICATIONS

Model:	440KB	9240B	635TR
Type:	18GA Medium Wire Staples	18GA Medium Wire Staples	16GA Heavy Wire Staples
Length:	16-40mm(5/8"-1 5/8")	25-40mm(1"-1 5/8")	19-35mm(3/4"-1 3/8")
Width:	1.27mm(.050")	1.27mm(.050")	1.4mm(.055")
Thickness:	1.05mm(.041")	1.05mm(.041")	1.6mm(.062")
Crown:	5.85mm(1/4")	8.85mm(5/16")	6mm(1/4")
Collation Type:	Glued Strip	Glued Strip	Glued Strip

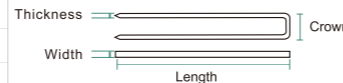

TOOL SPECIFICATIONS

Model:	440KB	9240B	635TR
Weight:	2.1kg/4.63lbs	1.97kg/4.34lbs	1.95kg/4.3lbs
Height:	270mm/10.62"	246mm/9.68"	246mm/9.68"
Length:	298mm/11.73"	310mm/12.020"	310mm/12.20"
Width:	73mm/2.87"	73mm/2.87"	73mm/2.87"
Capacity:	140pcs	100pcs	100pcs
Operating Pressure:	80-120psi	80-120psi	80-120psi
Air Inlet:	1/4"NPT	1/4"NPT	1/4"NPT
Trigger:	Contact	Contact	Contact

Premium
16 GA & 17 GA
Heavy Wire Stapler
For Professionals

Perfect in details



MT-N851-H

7/16" Crown Heavy Wire Stapler

FEATURES

- ▶ Light weight
- ▶ Well-balanced
- ▶ Powerful
- ▶ Depth control with a simple adjustable knob
- ▶ Single and rapid firing switchable mechanism
- ▶ Quick jams release

APPLICATIONS

- ▶ Solid wood furniture
- ▶ Wooden packing boxes
- ▶ Sofa frame
- ▶ Sheathing
- ▶ Roof decking
- ▶ Subflooring etc

FASTENER

Type:	17GA Heavy Wire Staples	16GA Heavy Wire Staples
Length:	25-50mm(1"-2")	25-51mm(1"-2")
Width:	1.45mm(.057")	1.6mm(.063")
Thickness:	1.3mm(.051")	1.4mm(.055")
Crown:	10.5mm(7/16")	10.8mm(7/16")
Collation Type:	Glued Strip	Glued Strip

TOOL SPECIFICATIONS

Weight:	2.5kg/5.51lbs	Capacity:	140pcs
Height:	288mm/11.33"	Operating Pressure:	80-120psi
Length:	370mm/14.56"	Air Inlet:	1/4"NPT
Width:	93mm/3.66"	Trigger:	Contact

Type 14

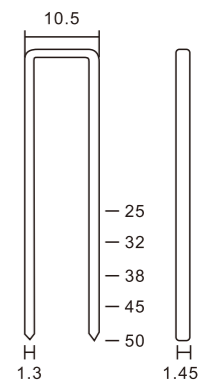

Type N

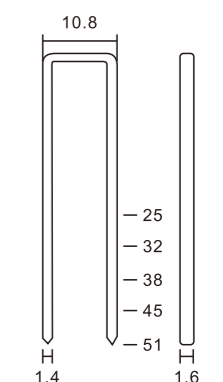

Premium 16GA & 17GA Heavy Wire Stapler For Professionals

Perfect in details



N851-L

7/16" Crown Heavy Wire Stapler

FEATURES	APPLICATIONS
<ul style="list-style-type: none"> Well-balanced Light weight Depth control with a simple adjustable knob Quick jams release 	<ul style="list-style-type: none"> Solid wood furniture Wooden packing boxes Sofa frame Sheathing Roof decking Subflooring etc

FASTENER	
Type:	17GA Heavy Wire Staples 16GA Heavy Wire Staples
Length:	25-50mm(1"-2") 25-51mm(1"-2")
Width:	1.45mm(.057") 1.6mm(.063")
Thickness:	1.3mm(.051") 1.4mm(.055")
Crown:	10.5mm(7/16") 10.8mm(7/16")
Collation Type:	Glued Strip Glued Strip

TOOL SPECIFICATIONS			
Weight:	2.2kg/4.85lbs	Capacity:	140pcs
Height:	288mm/11.33"	Operating Pressure:	80-120psi
Length:	370mm/14.56"	Air Inlet:	1/4"NPT
Width:	93mm/3.66"	Trigger:	Contact

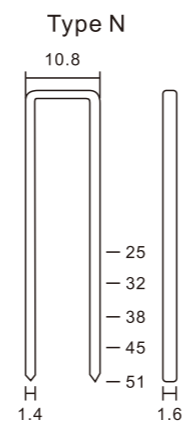
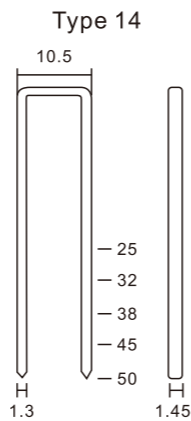

16 GA
HEAVY WIRE
STAPLE

N851F

7/16" Crown Heavy Wire Stapler

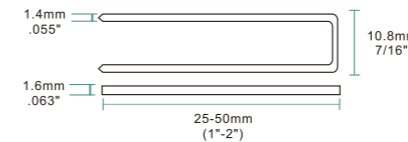

FEATURES	APPLICATIONS
<ul style="list-style-type: none"> Powerful Rubber comfort grip Well-balanced 	<ul style="list-style-type: none"> Solid wood furniture Wooden packing boxes Sofa frame Sheathing Roof decking Subflooring etc

FASTENER		SIMILAR TOOLS	
Type:	16GA Heavy Wire Staples	<ul style="list-style-type: none"> BeA 14/50-763 SENCO SN45XP HITACHI N5008A 	
Length:	25-50mm(1"-2")		
Width:	1.6mm(.062")		
Thickness:	1.4mm(.055")		
Crown:	10.8mm(7/16")		
Collation Type:	Glued Strip		

TOOL SPECIFICATIONS			
Weight:	2.8kg/6.17lbs	Capacity:	140pcs
Height:	287mm/11.29"	Operating Pressure:	80-120psi
Length:	340mm/13.38"	Air Inlet:	1/4"NPT
Width:	100mm/3.93"	Trigger:	Contact

16 GA
HEAVY WIRE
STAPLE

PW2638-L

1" Crown Heavy Wire Stapler

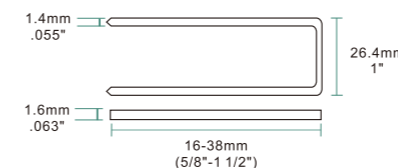

FEATURES	APPLICATIONS
<ul style="list-style-type: none"> Light weight Rapid firing Rubber comfort grip Quick jams release 	<ul style="list-style-type: none"> Windows & Door Corrugated carton to skid For miter joint applications

FASTENER		SIMILAR TOOLS	
Type:	16GA Heavy Wire Staples	<ul style="list-style-type: none"> SENCO WC 150XP 	
Length:	16-38mm(5/8"-1 1/2")		
Width:	1.6mm(.062")		
Thickness:	1.4mm(.055")		
Crown:	26.4mm(1")		
Collation Type:	Glued Strip		

TOOL SPECIFICATIONS			
Weight:	2.5kg/5.51lbs	Capacity:	140pcs
Height:	272mm/10.70"	Operating Pressure:	80-120psi
Length:	372mm/14.64"	Air Inlet:	3/8"NPT
Width:	83mm/3.26"	Trigger:	Contact

22^{GA}
FINE WIRE
STAPLE

71 Series

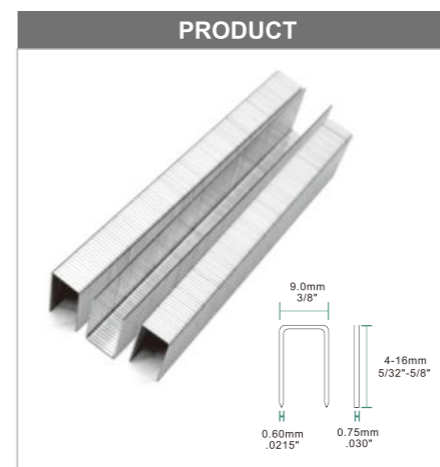

STAPLE SPECIFICATIONS				
MODEL	SIZE	FINISH	BOX / QTY	BOX / CTN
7104	5/32"(4mm)	Galv	10000	20
7106	1/4"(6mm)	Galv	10000	20
7108	5/16"(8mm)	Galv	10000	20
7110	3/8"(10mm)	Galv	10000	20
7112	1/2"(12mm)	Galv	10000	20
7114	9/16"(14mm)	Galv	10000	20
7116	5/8"(16mm)	Galv	10000	20

21^{GA}
FINE WIRE
STAPLE

80 Series

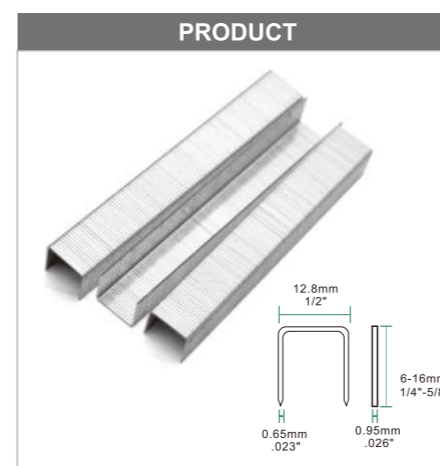

STAPLE SPECIFICATIONS				
MODEL	SIZE	FINISH	BOX / QTY	BOX / CTN
8006	1/4"(6mm)	Galv	10000	20
8008	5/15"(8mm)	Galv	10000	20
8010	3/8"(10mm)	Galv	10000	10
8012	1/2"(12mm)	Galv	10000	10
8014	9/16"(14mm)	Galv	10000	10
8016	5/8"(16mm)	Galv	10000	10

20^{GA}
FINE WIRE
STAPLE

50 Series

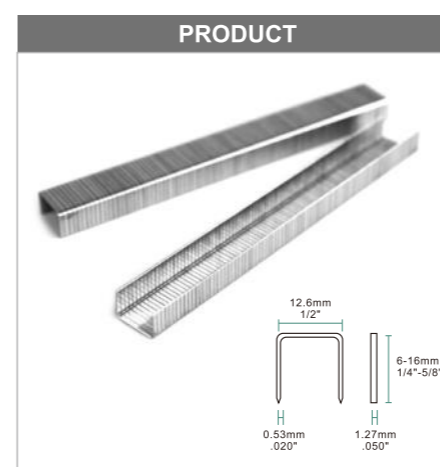

STAPLE SPECIFICATIONS				
MODEL	SIZE	FINISH	BOX / QTY	BOX / CTN
5006	1/4"(6mm)	Galv	5000	20
5008	5/15"(8mm)	Galv	5000	20
5010	3/8"(10mm)	Galv	5000	20
5012	1/2"(12mm)	Galv	5000	20
5014	9/16"(14mm)	Galv	5000	20
5016	5/8"(16mm)	Galv	5000	20

22 GA
FINE WIRE
STAPLE

10F Series

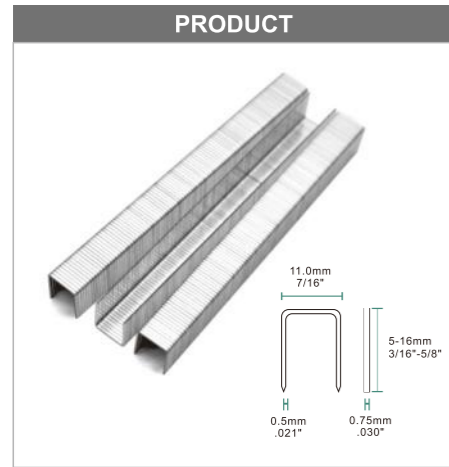

STAPLE SPECIFICATIONS				
MODEL	SIZE	FINISH	BOX / QTY	BOX / CTN
1005F	3/16"(5mm)	Galv	10000	20
1006F	1/4"(6mm)	Galv	10000	20
1007F	.276"(7mm)	Galv	10000	20
1008F	5/16"(8mm)	Galv	10000	20
1010F	3/8"(10mm)	Galv	10000	20
1012F	1/2"(12mm)	Galv	10000	20
1014F	9/16"(14mm)	Galv	10000	20
1016F	5/8"(16mm)	Galv	10000	20

20 GA
FINE WIRE
STAPLE

10J Series

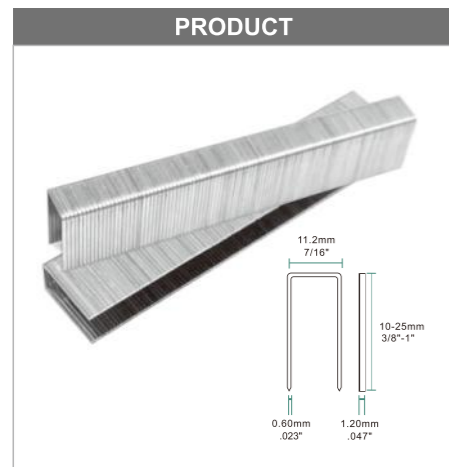

STAPLE SPECIFICATIONS				
MODEL	SIZE	FINISH	BOX / QTY	BOX / CTN
J1004	5/32"(4mm)	Galv	5000	20
J1006	1/4"(6mm)	Galv	5000	20
J1008	5/16"(8mm)	Galv	5000	20
J1010	3/8"(10mm)	Galv	5000	20
J1013	1/2"(13mm)	Galv	5000	10
J1016	5/16"(16mm)	Galv	5000	10
J1019	3/4"(19mm)	Galv	5000	10
J1022	7/8"(22mm)	Galv	5000	10
J1025	1"(25mm)	Galv	5000	10

20 GA
FINE WIRE
STAPLE

J4 Series

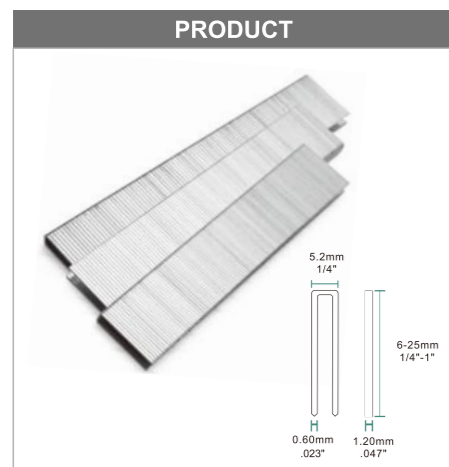

STAPLE SPECIFICATIONS				
MODEL	SIZE	FINISH	BOX / QTY	BOX / CTN
J406	1/4"(6mm)	Galv	5000	20
J408	5/15"(8mm)	Galv	5000	20
J410	3/8"(10mm)	Galv	5000	20
J413	1/2"(13mm)	Galv	5000	20
J416	5/8"(16mm)	Galv	5000	20
J419	3/4"(19mm)	Galv	5000	20
J422	7/8"(22mm)	Galv	5000	20
J425	1"(25mm)	Galv	5000	20

18 GA
MEDIUM WIRE
STAPLE

90/K Series

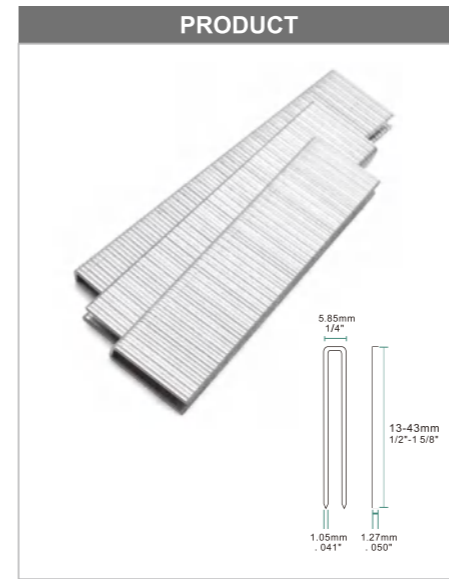

STAPLE SPECIFICATIONS				
MODEL	SIZE	FINISH	BOX / QTY	BOX / CTN
K13	1/2"(13mm)	Galv	5000	10
K16	5/8"(16mm)	Galv	5000	10
K19	3/4"(19mm)	Galv	5000	10
K22	7/8"(22mm)	Galv	5000	10
K25	1"(25mm)	Galv	5000	10
K28	1 1/8"(28mm)	Galv	5000	10
K30	1 3/16"(30mm)	Galv	5000	10
K32	1 1/4"(32mm)	Galv	5000	10
K35	1 3/8"(35mm)	Galv	5000	10
K38	1 1/2"(38mm)	Galv	5000	10
K40	1 5/8"(40mm)	Galv	5000	10

18 GA
MEDIUM WIRE
STAPLE

92 Series



STAPLE SPECIFICATIONS				
MODEL	SIZE	FINISH	BOX / QTY	BOX / CTN
9210	3/8"(10mm)	Galv	5000	10
9225	1"(25mm)	Galv	5000	10
9235	1 3/8"(35mm)	Galv	5000	8
9238	1 1/2"(38mm)	Galv	5000	8
9240	1 5/8"(40mm)	Galv	5000	8

16 GA
HEAVY WIRE
STAPLE

N Series

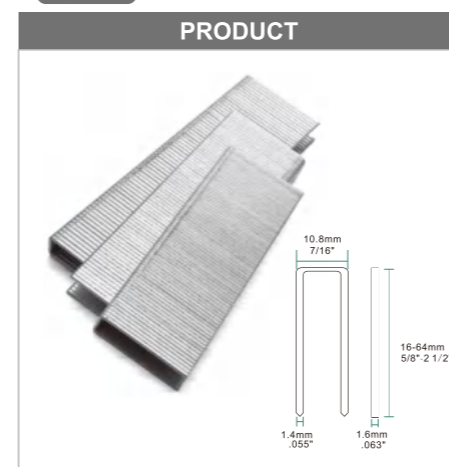

STAPLE SPECIFICATIONS				
MODEL	SIZE	FINISH	BOX / QTY	BOX / CTN
N16	5/8"(16mm)	Galv	10000	1
N19	3/4"(19mm)	Galv	10000	1
N22	7/8"(22mm)	Galv	10000	1
N25	1"(25mm)	Galv	10000	1
N28	1 1/8"(28mm)	Galv	10000	1
N32	1 1/4"(32mm)	Galv	10000	1
N35	1 3/8"(35mm)	Galv	10000	1
N38	1 1/2"(38mm)	Galv	10000	1
N40	1 9/16"(40mm)	Galv	10000	1
N45	1 3/4"(45mm)	Galv	10000	1
N50	2"(50mm)	Galv	10000	1

18^{GA}
BRAD NAILS

MTF32
1 1/4" Brad Nailer

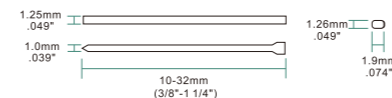

FEATURES	
▶	360° exhaust deflector
▶	Light weight & Well-balanced
▶	Powerful for heavy duty applications
▶	Ergonomic handle with rubber comfort grip

APPLICATIONS	
▶	Windows & Door
▶	Cabinets
▶	Interior Decoration

FASTENER	
Type:	18GA Brad Nails
Length:	10-32mm(3/8"-1 1/4")
Width:	1.25mm(.049")
Thickness:	1.0mm(.039")
Collation Type:	Glued Strip

SIMILAR TOOLS	

TOOL SPECIFICATIONS			
Weight:	1.25kg/2.76lbs	Capacity:	100pcs
Height:	125mm/4.92"	Operating Pressure:	60-100psi
Length:	240mm/9.44"	Air Inlet:	1/4"NPT
Width:	60mm/2.36"	Trigger:	Trigger

18^{GA}
BRAD NAILS

F32D
1 1/4" Brad Nailer

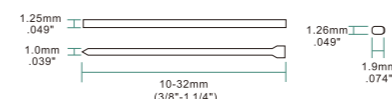

FEATURES	
▶	360° exhaust deflector
▶	Light weight & Well-balanced
▶	Powerful for heavy duty applications
▶	Quick jams release

APPLICATIONS	
▶	Windows & Door
▶	Cabinets
▶	Interior Decoration

FASTENER	
Type:	18GA Brad Nails
Length:	10-32mm(3/8"-1 1/4")
Width:	1.25mm(.049")
Thickness:	1.0mm(.039")
Collation Type:	Glued Strip

SIMILAR TOOLS	

TOOL SPECIFICATIONS			
Weight:	1.22kg/2.69lbs	Capacity:	100pcs
Height:	190mm/7.48"	Operating Pressure:	60-100psi
Length:	247mm/9.72"	Air Inlet:	1/4"NPT
Width:	55mm/2.16"	Trigger:	Contact

18^{GA}
BRAD NAILS

F32
1 1/4" Brad Nailer

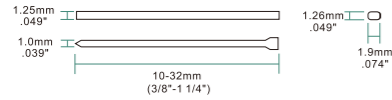

FEATURES

- ▶ Compact & durable gravity casting body
- ▶ Well-balanced
- ▶ Powerful for heavy duty applications
- ▶ Quick & easy side loading

APPLICATIONS

- ▶ Windows & Door
- ▶ Cabinets
- ▶ Interior Decoration

FASTENER

Type:	18GA Brad Nails
Length:	10-32mm(3/8"-1 1/4")
Width:	1.25mm(.049")
Thickness:	1.0mm(.039")
Collation Type:	Glued Strip

SIMILAR TOOLS

TOOL SPECIFICATIONS

Weight:	1.25kg/2.76lbs	Capacity:	100pcs
Height:	125mm/4.92"	Operating Pressure:	60-100psi
Length:	240mm/9.44"	Air Inlet:	1/4"NPT
Width:	60mm/2.36"	Trigger:	Trigger

18^{GA}
BRAD NAILS

F50C
2" Brad Nailer

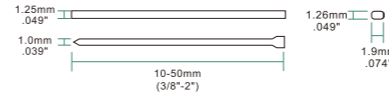

FEATURES

- ▶ 360° exhaust deflector
- ▶ Light weight & well-balanced
- ▶ Powerful for heavy duty applications
- ▶ Quick jams release

APPLICATIONS

- ▶ Windows & Door
- ▶ Cabinets
- ▶ Interior Decoration

FASTENER

Type:	18GA Brad Nails
Length:	10-50mm(3/8"-2")
Width:	1.25mm(.049")
Thickness:	1.0mm(.039")
Collation Type:	Glued Strip

SIMILAR TOOLS

TOOL SPECIFICATIONS

Weight:	1.38kg/3.04lbs	Capacity:	100pcs
Height:	238mm/9.37"	Operating Pressure:	57-100psi
Length:	250mm/9.84"	Air Inlet:	1/4"NPT
Width:	57mm/2.24"	Trigger:	Contact

18^{GA}
BRAD NAILS

F50G
2" Brad Nailer

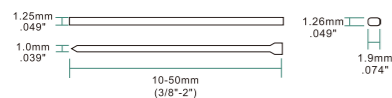

FEATURES

- ▶ Compact & durable gravity casting body
- ▶ Well-balanced
- ▶ Powerful for heavy duty applications
- ▶ Quick & easy side loading

APPLICATIONS

- ▶ Windows & Door
- ▶ Cabinets
- ▶ Interior Decoration

FASTENER

Type:	18GA Brad Nails
Length:	10-50mm(3/8"-2")
Width:	1.25mm(.049")
Thickness:	1.0mm(.039")
Collation Type:	Glued Strip

SIMILAR TOOLS

TOOL SPECIFICATIONS

Weight:	1.38kg/3.04lbs	Capacity:	100pcs
Height:	230mm/9.05"	Operating Pressure:	60-100psi
Length:	240mm/9.44"	Air Inlet:	1/4"NPT
Width:	65mm/2.55"	Trigger:	Contact

16^{GA}
BRAD NAILS

T64A
2 1/2" Brad Nailer

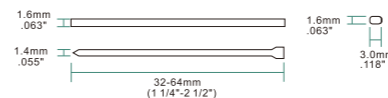

FEATURES

- ▶ 360° exhaust deflector
- ▶ Light weight & Well-balanced
- ▶ Powerful for heavy duty applications
- ▶ Quick jams release

APPLICATIONS

- ▶ Windows & Door
- ▶ Cabinets
- ▶ Interior Decoration

FASTENER

Type:	16GA Brad Nails
Length:	32-64mm(1 1/4"-2 1/2")
Width:	1.6mm(.063")
Thickness:	1.4mm(.055")
Collation Type:	Glued Strip

SIMILAR TOOLS

- ▶ MAX NF565/16
- ▶ Bostitch FN1664K
- ▶ SENCO FinishPro 32

TOOL SPECIFICATIONS

Weight:	1.75kg/3.86lbs	Capacity:	100pcs
Height:	282mm/11.10"	Operating Pressure:	70-100psi
Length:	298mm/11.73"	Air Inlet:	1/4"NPT
Width:	73mm/2.87"	Trigger:	Contact

16_{GA}
BRAD NAILS

T50SA
2" Brad Nailer

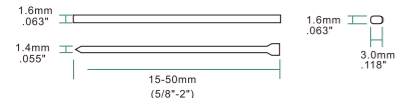

FEATURES

- ▶ Compact & durable gravity casting body
- ▶ Well-balanced
- ▶ Powerful for heavy duty applications
- ▶ Quick and easy side loading

APPLICATIONS

- ▶ Windows & Door
- ▶ Cabinets
- ▶ Interior Decoration

FASTENER

Type:	16GA Brad Nails
Length:	15-50mm(3/8"-2")
Width:	1.6mm(.063")
Thickness:	1.4mm(.055")
Collation Type:	Glued Strip

SIMILAR TOOLS

TOOL SPECIFICATIONS

Weight:	1.86kg/4.10lbs	Capacity:	100pcs
Height:	255mm/10.03"	Operating Pressure:	70-100psi
Length:	294mm/11.57"	Air Inlet:	1/4"NPT
Width:	77mm/3.03"	Trigger:	Contact

16_{GA}
BRAD NAILS

FST50
2" Brad Nailer

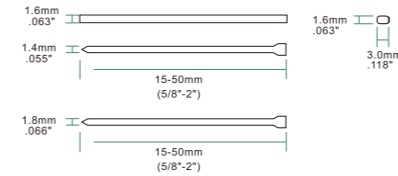

FEATURES

- ▶ Compact & durable gravity casting body
- ▶ Well-balanced
- ▶ Powerful for heavy duty applications
- ▶ Quick & easy side loading

APPLICATIONS

- ▶ Windows & Door
- ▶ Cabinets
- ▶ Interior Decoration

FASTENER

Type:	16GA Brad Nails
Length:	15-50mm(3/8"-2")
Width:	1.6mm(.063")
Thickness:	1.4mm(.055")
Collation Type:	Glued Strip

SIMILAR TOOLS

TOOL SPECIFICATIONS

Weight:	1.59kg/3.51lbs	Capacity:	100pcs
Height:	255mm/10.03"	Operating Pressure:	70-100psi
Length:	275mm/10.82"	Air Inlet:	1/4"NPT
Width:	62mm/2.44"	Trigger:	Contact

16_{GA}
BRAD NAILS

T50MA
2" Brad Nailer

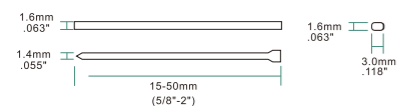

FEATURES

- ▶ Compact & durable gravity casting body
- ▶ Well-balanced
- ▶ Powerful for heavy duty applications
- ▶ Quick & easy side loading

APPLICATIONS

- ▶ Windows & Door
- ▶ Cabinets
- ▶ Interior Decoration

FASTENER

Type:	16GA Brad Nails
Length:	15-50mm(3/8"-2")
Width:	1.6mm(.063")
Thickness:	1.4mm(.055")
Collation Type:	Glued Strip

SIMILAR TOOLS

TOOL SPECIFICATIONS

Weight:	2.44kg/5.38lbs	Capacity:	100pcs
Height:	257mm/10.11"	Operating Pressure:	70-100psi
Length:	312mm/12.28"	Air Inlet:	1/4"NPT
Width:	78mm/3.07"	Trigger:	Contact

14_{GA}
CONCRETE NAILS

ST64
Concrete T Nailer

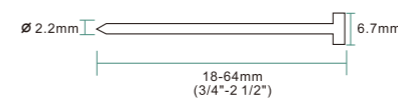

FEATURES

- ▶ Well-balanced
- ▶ Powerful

APPLICATIONS

- ▶ Windows & Door
- ▶ Cabinets
- ▶ Interior Decoration

FASTENER

Type:	14GA Brad Nail
Length:	18-64mm(3/4"-2 1/2")
Shank Dia.:	2.2mm(.089")
Head Dia.:	6.7mm(1/4")

SIMILAR TOOLS

TOOL SPECIFICATIONS

Weight:	3.0kg/6.61lbs	Capacity:	50pcs
Height:	267mm/10.51"	Operating Pressure:	70-100psi
Length:	318mm/12.51"	Air Inlet:	1/4"NPT
Width:	95mm/3.74"	Trigger:	Contact



CS3025

1" Concrete and Steel Nailer

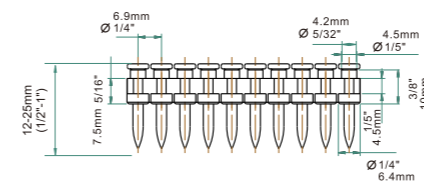

FEATURES
▶ Works with standard compressed air
▶ Powerful for heavy duty applications
▶ Rubber comfort grip
▶ Durable driver and bumper for long life

APPLICATIONS
▶ Wood to steel / concrete
▶ Drywall track to steel / concrete
▶ Concrete furring

FASTENER
Type: Plastic Collected Concrete Nails
Length: 12-25mm(1/2"-1")
Shank Dia.: 2.6&2.9mm(.104"&.114")
Head Dia.: 6.4mm(.252")
Collation Type: Plastic Collected

SIMILAR TOOLS

TOOL SPECIFICATIONS		
Weight:	2.78kg/6.13lbs	Capacity: 20pcs
Height:	317mm/12.48"	Operating Pressure: 70-100psi
Length:	342mm/13.46"	Air Inlet: 1/4"NPT
Width:	104mm/4.09"	Trigger: Contact

MTCS3040L

1 1/2" Concrete and Steel Nailer

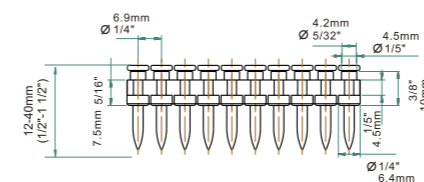

FEATURES
▶ Works with standard compressed air
▶ Powerful for heavy duty applications
▶ Rubber comfort grip
▶ Durable driver and bumper for long life

APPLICATIONS
▶ Wood to steel / concrete
▶ Drywall track to steel / concrete
▶ Concrete furring

FASTENER
Type: Plastic Collected Concrete Nails
Length: 12-40mm(1/2"-1 1/2")
Shank Dia.: 2.6&2.9mm(.104"&.114")
Head Dia.: 6.4mm(.252")
Collation Type: Plastic Collected

SIMILAR TOOLS

TOOL SPECIFICATIONS		
Weight:	2.9kg/6.39lbs	Capacity: 40pcs
Height:	337mm/13.26"	Operating Pressure: 70-100psi
Length:	342mm/13.46"	Air Inlet: 1/4"NPT
Width:	104mm/4.09	Trigger: Contact



MTCS3040

1 1/2" Concrete and Steel Nailer

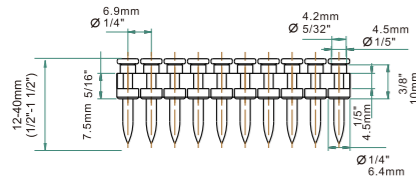

FEATURES	
▶ Works with standard compressed air	
▶ Powerful for heavy duty applications	
▶ Rubber comfort grip	
▶ Durable driver and bumper for long life	

APPLICATIONS	
▶ Wood to steel / concrete	
▶ Drywall track to steel / concrete	
▶ Concrete furring	

FASTENER	
Type:	Concrete Nail
Length:	12-40mm(1/2"-1 1/2")
Shank Dia.:	2.6&2.9mm(.104"&.114")
Head Dia.:	6.4mm(.252")
Collation Type:	Plastic Collected

SIMILAR TOOLS	

TOOL SPECIFICATIONS			
Weight:	3.42kg/7.54lbs	Capacity:	40pcs
Height:	360mm/14.17"	Operating Pressure:	70-100psi
Length:	480mm/18.89"	Air Inlet:	1/4"NPT
Width:	120mm/4.72"	Trigger:	Contact

MT-G38

1 1/2" Gas Concrete and Steel Nailer

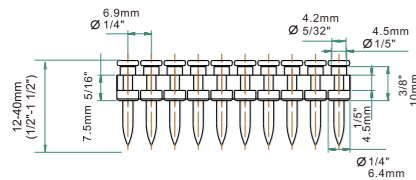

FEATURES	
▶ Well-balance, powerful	
▶ High efficiency, rapid nailing performance	
▶ Easy to disassemble for clean and maintenance	
▶ Compact design, long life span	

APPLICATIONS	
▶ Wood to steel / concrete	
▶ Drywall track to steel / concrete	
▶ Concrete furring	

FASTENER	
Type:	Plastic Collected Concrete Nails
Length:	12-40mm(1/2"-1 1/2")
Shank Dia.:	2.6&2.9mm(.104"&.114")
Head Dia.:	6.4mm(.252")
Collation Type:	Plastic Collected

SIMILAR TOOLS	

TOOL SPECIFICATIONS			
Weight:	3.65kg/8.05lbs	Capacity:	30pcs
Height:	400mm/15.74"	Operating Pressure:	/
Length:	350mm/13.77"	Air Inlet:	/
Width:	108mm/4.25"	Trigger:	Contact

PICTURE FRAME & ARTCRAFT



P515

Pneumatic Flex Point Tacker

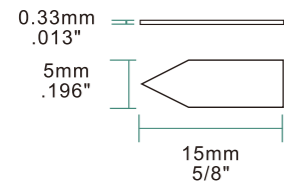

FEATURES		APPLICATIONS	
<ul style="list-style-type: none"> ▶ Light weight & well-balanced ▶ Rubber comfort grip ▶ Ideal for high volume production ▶ Quick & easy bottom loading 		<ul style="list-style-type: none"> ▶ Picture Frame 	
FASTENER		SIMILAR TOOLS	
Type:	Flex Point Pins	▶ Omer 53-53.4	
Length:	15mm(5/8")		
Thickness:	0.33mm(.013")		
Width:	5mm(.196")		

TOOL SPECIFICATIONS			
Weight:	0.94kg/2.07lbs	Capacity:	200pcs
Height:	162mm/6.37"	Operating Pressure:	60-100psi
Length:	195mm/7.67"	Air Inlet:	1/4"NPT
Width:	43mm/1.69"	Trigger:	Trigger

18^{GA}
BRAD NAILS

HF18

Manual Hard Points Tacker

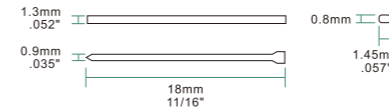

FEATURES		APPLICATIONS	
<ul style="list-style-type: none"> ▶ Light weight & Well-balanced ▶ Depth adjustment ▶ Quick & easy front loading ▶ Air free, convenient to use 		<ul style="list-style-type: none"> ▶ Picture Frame 	
FASTENER		SIMILAR TOOLS	
Type:	Hard Point Brads	▶ SALCO F-18	
Length:	18mm(11/16")		
Width:	1.3mm(.052")		
Thickness:	0.9mm(.035")		
Collation Type:	Glued Strip		

TOOL SPECIFICATIONS			
Weight:	0.65kg/1.43lbs	Capacity:	100pcs
Height:	127mm/5"	Operating Pressure:	/
Length:	190mm/7.48"	Air Inlet:	/
Width:	31mm/1.22"	Trigger:	Manual

HM515

Manual Flex Point Tacker

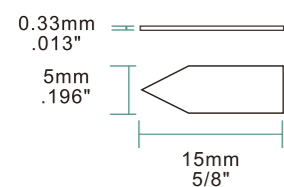

FEATURES		APPLICATIONS	
<ul style="list-style-type: none"> ▶ Light weight & well-balanced ▶ Depth adjustment ▶ Quick & easy front loading ▶ Air free, convenient to use 		<ul style="list-style-type: none"> ▶ Picture Frame 	
FASTENER		SIMILAR TOOLS	
Type:	Flex Point Pins	▶ Omer 53-53.4	
Length:	15mm(5/8")		
Thickness:	0.33mm(.013")		
Width:	5mm(.196")		

TOOL SPECIFICATIONS			
Weight:	0.62kg/1.37lbs	Capacity:	100pcs
Height:	124mm/4.88"	Operating Pressure:	/
Length:	203mm/7.99"	Air Inlet:	/
Width:	40mm/1.57"	Trigger:	Manual

V1015B

V-Nailer

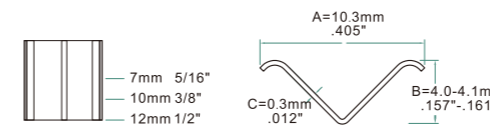

FEATURES		APPLICATIONS	
<ul style="list-style-type: none"> ▶ Light weight & Well-balanced ▶ Rubber comfort grip ▶ Ideal for miter joint applications 		<ul style="list-style-type: none"> ▶ Picture Frame ▶ Windows Door 	
FASTENER		SIMILAR TOOLS	
Type:	V-Nails	▶ Omer VNII.15	
Length:	7-112mm(5/16"-1/2")		
Thickness:	0.3mm(.012")		
Height:	4.0-4.1mm(.157"-.161")		
Width:	10.3mm(.405")		
Collation type:	Glued Strip		

TOOL SPECIFICATIONS			
Weight:	1.49kg/3.28lbs	Capacity:	200pcs
Height:	208mm/8.18"	Operating Pressure:	60-100
Length:	270mm/10.62"	Air Inlet:	1/4"NPT
Width:	65mm/2.55"	Trigger:	Trigger

ZN1400

Deco Nailer



FEATURES	APPLICATIONS
▶ Light weight	▶ Furniture
▶ Rubber comfort grip	▶ Picture Frame
▶ Magnetic nosepiece	▶ Shoes

TOOL SPECIFICATIONS			
Weight:	0.64kg/1.41lbs	Capacity:	1pcs
Height:	174mm/6.85"	Operating Pressure:	60-100psi
Length:	208mm/8.18"	Air Inlet:	1/4"NPT
Width:	42mm/1.65"	Trigger:	Trigger

MODEL	ZN0630	ZN0750	ZN0860	MODEL	ZN1820	ZN2030	ZN2230
D(mm)	6.3	7.5	8.6	D(mm)	18.2	20.3	22.3
MODEL	ZN0960	ZN1080	ZN1170	MODEL	ZN2530	ZN2830	ZN3030
D(mm)	9.6	10.8	11.7	D(mm)	25.3	28.3	30.0
MODEL	ZN1230	ZN1400	ZN1620				
D(mm)	12.3	14.0	16.2				

Step1 Put the studs on the plate



Step2 Put the nose on the studs



Step3 Actuate the trigger to shoot



ZN-12

Automatic Feeding Deco Nailer



FEATURES	APPLICATIONS
▶ Speed control feeding	▶ Furniture
▶ Light weight & well-balanced	▶ Picture Frame
▶ Rapid & easy-loading	▶ Shoes
▶ Ideal for high-volume production	

FASTENER	SIMILAR TOOLS
Type: Deco Nail	
Length: 6-16mm(1/4"-5/8")	
Head Dia. 8.5-10.5mm(.033"-.041")	
Head Height: 3.3-4.0mm(.012"-.015")	
Collation Type: /	

TOOL SPECIFICATIONS			
Weight:	1.09kg/2.40lbs	Capacity:	50pcs
Height:	195mm/7.67"	Operating Pressure:	60-100
Length:	245mm/9.64"	Air Inlet:	1/4"NPT
Width:	95mm/3.74"	Trigger:	Trigger

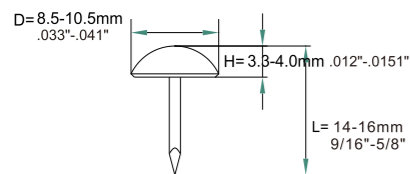

CARTON CLOSING



16^{GA}
CARTON
STAPLE

HB3515 Manual Carton Stapler

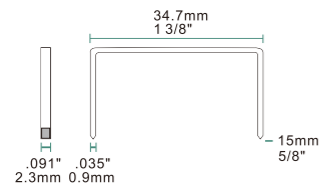

FEATURES	APPLICATIONS
▶ Adjustable depth control	▶ Carton Box Closing
▶ Light weight & well-balanced	
▶ Air free, convenient to use	

FASTENER	SIMILAR TOOLS
Type: Carton Staples	
Length: 15mm(5/8")	
Width: 2.3mm(.09")	
Thickness: 0.9mm(.035")	
Crown: 34.7mm(1 3/8")	
Collation Type: Glued Strip	

TOOL SPECIFICATIONS			
Weight:	2.66kg/5.86lbs	Capacity:	100pcs
Height:	267mm/10.51"	Operating Pressure:	/
Length:	360mm/14.17"	Air Inlet:	/
Width:	105mm/4.13"	Trigger:	Manual

16^{GA}
CARTON
STAPLE

ADCS-19 Pneumatic Carton Stapler

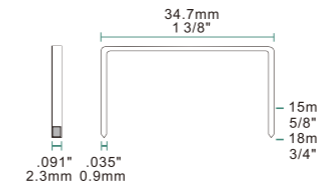
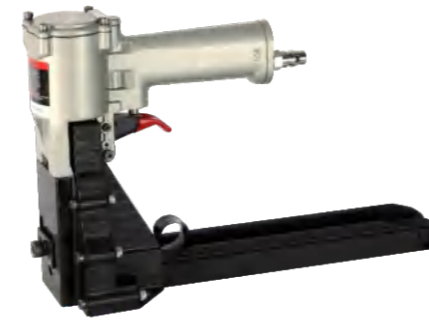

FEATURES	APPLICATIONS
▶ Built in silencer for low noise	▶ Carton Box Closing
▶ Light weight & well-balanced	
▶ Ideal for heavy-volume production	

FASTENER	SIMILAR TOOLS
Type: Carton Staples	▶ BeAAT A18 AIR
Length: 15-18mm(5/8"-3/4")	▶ Bostitch DS3519
Crown: 34.7mm(1 3/8")	▶ OMER 35.18
Collation Type: Glued Strip	

TOOL SPECIFICATIONS			
Weight:	2.13kg/4.70lbs	Capacity:	100pcs
Height:	220mm/8.66"	Operating Pressure:	70-100psi
Length:	342mm/13.46"	Air Inlet:	1/4"NPT
Width:	115mm/4.52"	Trigger:	Trigger

16^{GA}
CARTON
STAPLE

HB3518 Manual Carton Stapler

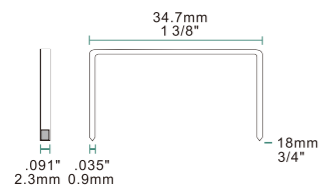

FEATURES	APPLICATIONS
▶ Forming control	▶ Carton Box Closing
▶ Depth control	
▶ Light weight	

FASTENER	SIMILAR TOOLS
Type: Carton Staples	▶ BeA MTA18
Length: 18mm(3/4")	▶ Bostitch MS3519
Width: 2.3mm(.09")	▶ OMER 35.18M
Thickness: 0.9mm(.035")	
Crown: 34.7mm(1 3/8")	
Collation Type: Glued Strip	

TOOL SPECIFICATIONS			
Weight:	2.66kg/5.86lbs	Capacity:	100pcs
Height:	267mm/10.51"	Operating Pressure:	/
Length:	360mm/14.17"	Air Inlet:	/
Width:	105mm/4.13"	Trigger:	Manual

16^{GA}
CARTON
STAPLE

ADCS-22 Pneumatic Carton Stapler

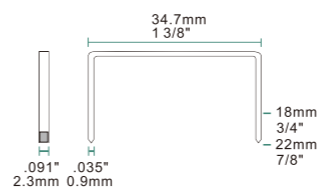

FEATURES	APPLICATIONS
▶ Built in silencer for low noise	▶ Carton Box Closing
▶ Light weight & well-balanced	
▶ Ideal for heavy-volume production	

FASTENER	SIMILAR TOOLS
Type: Carton Staples	▶ BeAAT A22 AIR
Length: 18-22mm(3/4"-7/8")	▶ Bostitch DS3522
Crown: 34.7mm(1 3/8")	▶ OMER 35.22
Collation Type: Glued Strip	

TOOL SPECIFICATIONS			
Weight:	2.15kg/4.74lbs	Capacity:	100pcs
Height:	220mm/8.66"	Operating Pressure:	70-100psi
Length:	342mm/13.46"	Air Inlet:	1/4"NPT
Width:	115mm/4.52"	Trigger:	Trigger

RATA-19

Pneumatic Roll Carton Stapler

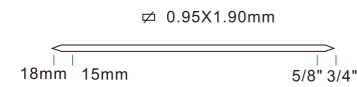

FEATURES	APPLICATIONS
▶ Built in silencer for low noise	▶ Carton Box Closing
▶ Light weight & well-balanced	
▶ Quick jams release	
▶ Ideal for heavy-volume production	

FASTENER	SIMILAR TOOLS
Type: Carton Staple	▶ Bostitch RAB-19
Length: 15&18mm(5/8\"&3/4")	▶ Omer D.18 ROLL
Width: 1.9mm(.075")	
Thickness: 0.95mm(.037")	
Collation Type: Glue	

TOOL SPECIFICATIONS			
Weight: 2.38kg/5.25lbs	Capacity: 1000pcs		
Height: 230mm/9.05"	Operating Pressure: 70-100psi		
Length: 233mm/9.17"	Air Inlet: 1/4"NPT		
Width: 115mm/4.52"	Trigger: Trigger		

RAIA-19

Pneumatic Roll Carton Stapler

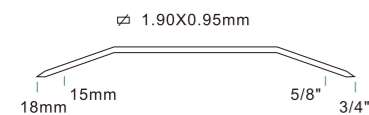

FEATURES	APPLICATIONS
▶ Built in silencer for low noise	▶ Carton Box Closing
▶ Light weight & well-balanced	
▶ Quick jams release	
▶ Ideal for heavy-volume production	

FASTENER	SIMILAR TOOLS
Type: Carton Staple	▶ BeA CT IC 1823 COIL
Length: 15&18mm(5/8\"&3/4")	▶ Bostitch RAB-19
Width: 1.9mm(.075")	▶ Omer C.18 ROLL
Thickness: 0.95mm(.037")	
Collation Type: Glue	

TOOL SPECIFICATIONS			
Weight: 2.38kg/5.25lbs	Capacity: 1000pcs		
Height: 230mm/9.05"	Operating Pressure: 70-100psi		
Length: 233mm/9.17"	Air Inlet: 1/4"NPT		
Width: 115mm/4.52"	Trigger: Trigger		

SPECIAL



15.5GA
FLOORING
STAPLE

MFS50

Pneumatic Mallet Actuated
Flooring Stapler

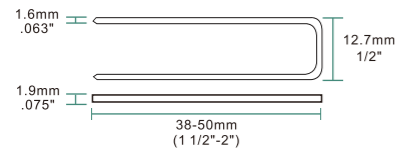

FEATURES	APPLICATIONS
<ul style="list-style-type: none"> ▶ Mallet actuated ▶ Powerful, well-balanced ▶ Ergonomic handle reduces user fatigue 	<ul style="list-style-type: none"> ▶ Flooring

FASTENER	SIMILAR TOOLS
Type: Flooring Staple Length: 38-50mm(1 1/2"-2") Width: 1.9mm(.075") Thickness: 1.6mm(.063") Crown: 12.7mm(1/2") Gauge Size: 15.5GA	<ul style="list-style-type: none"> ▶ Bostitch MIIIFS ▶ SENCO SHFS200 ▶ Grip-Rite GR200FS

TOOL SPECIFICATIONS			
Weight:	5.1kg/11.24lbs	Capacity:	90pcs
Height:	564mm/22.20"	Operating Pressure:	70-100
Length:	400mm/15.74"	Air Inlet:	1/4"NPT
Width:	197mm/7.75"	Trigger:	Mallet Actuated

TH-1213F

Hammer Tacker

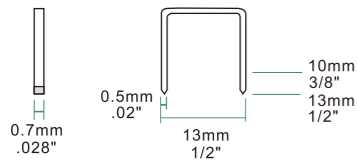

FEATURES	APPLICATIONS
<ul style="list-style-type: none"> ▶ Light weight ▶ Well-balanced 	<ul style="list-style-type: none"> ▶ Packaging

FASTENER	SIMILAR TOOLS
Type: Fine Wire Staple Length: 10-13mm(3/8"-1/2") Width: 0.7mm(.028") Thickness: 0.5mm(.02") Crown: 11.1mm(7/16") Collation Type: Glued Strip	<ul style="list-style-type: none"> ▶ MAX TH-S2

TOOL SPECIFICATIONS			
Weight:	0.66kg/1.46lbs	Capacity:	144pcs
Height:	71mm/2.79"	Operating Pressure:	/
Length:	315mm/12.40"	Air Inlet:	/
Width:	25mm/0.98"	Trigger:	Manual

Cylinder Set



Cylinder Cap



Bumper



Active Valve



Magazine



Driver Set



O-ring



Muzzle



Lubricant



meite special lubricant
Proper Lubrication is necessary for this pneumatic tool.
Lube oil through the air inlets before and after for each time use if not using an oiler.
Proper lubrication can increase the usage length of your tool also prevents rust from forming.
Use MEITE lube oil for best performance.

Safety Glass



meite Safety Glass
Always wear safety glasses in the work area.