

**meite**<sup>®</sup>

Guangdong Meite Mechanical Co.,Ltd.

Add: No.10, Shunjing St.,Hegui Industrial Park(B), Lishui Town, Nanhai District, Foshan, GD 528241, China

Tel : (0086)757-85126856 Email: export@gdmeite.com  
Fax : (0086)757-85126850 Website: www.meitertools.com

MT25-02 Version

**meite**<sup>®</sup>

TOOLS FOR PROFESSIONALS



**PROFESSIONAL TOOLS & FASTENERS**





## Your All-in-One Source for Pneumatic Tools, Fasteners, and Accessories.

Founded in 1996, Guangdong Meite Mechanical Co, Ltd. quickly established itself as a key player in the production of pneumatic products. Over the past two decades, we've broadened our range to include nail guns, staplers, fasteners, spray guns, and more. Our tools are trusted by professionals in sectors like furniture manufacturing, upholstery, construction, packaging, etc.

We are deeply committed to technological advancement and high-efficient manufacturing procedures to ensure our customers always receive products that embody quality and durability. Our expansive 70,000 m<sup>2</sup> (750,000 ft<sup>2</sup>) facility boasts cutting-edge CNC machinery, advanced heat treatment procedures, forging equipment, and state-of-the-art painting systems. We've secured both ISO 9001 and CE certifications.

Meite prioritizes customer feedback, crafting tools and fasteners tailored to their requirements. We remain unwavering in delivering top-tier products and expert services to our global clientele.

A large, modern industrial building with a white, grid-patterned facade. The word "meite" is written in large, bold, black lowercase letters across the upper part of the building, with a registered trademark symbol (®) to its right. The building has large glass windows and a prominent entrance area with a canopy. In the foreground, there is a paved area and a curved, dark structure that reflects the building and the sky. The sky is bright blue with scattered white clouds. Several palm trees and other greenery are planted around the building. A few cars are parked in the distance on the left side.

meite®



## CONTENTS

## 01

**Construction Nailer**

CN45R	02
CN65S	03
CN83F	04
CN425S	04
SN2183FA	05
SN2183F	05
SN3483F	06
DA6434	06
SF13021	06

## 02

**Industrial Coil Nailer**

CN38	08
CN55	08
CN65B	09
CN70B	09
CN80B	10
CN70E	10
CN80E	10
CN70DS	11
CN80DS	11
CN100DS	11
CN90	12
CN100B	12
CN100	12
CN100EPAL	13
CN130	13

## 03

**De-Nailer**

T50SC-B	15
NP45	15
NP55	15
NP70	15

## 04

**C Ring Plier**

SC712	17
SC760C	17
SC7C	18
SC7E	18
SC77XE	18
MTC560	19
MTC600	19
MTHC45	19

## 05

**Clipping Tool**

M66C	21
M65C	21
M46C	21
M45C	21
M66LB	22
M66L2	22
M65LB	22
M46LB	22

## 06

**Industrial Stapling Plier**

P88U	23
P88U-B	23

## 07

**Headless Pinner**

P625B	25
MP630B	25
MP635B	25
MP650B	26
MT840	26
MT850	26

## 08

**Fine Wire Stapler**

8016B	28
1013J	28
7116B	28
1010F	28
1416B	28
MT8016	29
MT7116	29
MT1416	29
MT8416	29
MT8016S	30
MT7116S	30
MT5016S	30
MT1416S	30
MT8416S	30
MT8016LN	31
MT7116LN	31
MT5016SLN	31
8016F2	32
7116	32
MTP5016	33
MTP8016	33
422J	33
1022J	33
8016-A	34
7116-A	34
8016-AL	34
7116-AL	34

**Medium Wire Stapler**

425K	35
440KB	36
MT432KLM	36
MT440KLM	36
9240B	37
9240C	37
635TR	37

**Heavy Wire Stapler**

MT-N851-H	38
N851-L	38
N851F	38
1440	39
1450	39
PW2638-L	39

## 09

**Brad Nailer**

MTF32	41
F32	41
F50G	41
F50C	42
T50SA	42
T50SA-C	42
T50MA	43
FST50	43
T64A	43

## 10

**Concrete and Steel Nailer**

ST38	45
ST64	45
ST64D	45
ST64E	46
ST64L	46
CS3025	46
MTCS3040L	46

## 11

**Picture Frame Tacker**

P515	48
HM515	48
V1015B	48

## 12

**Corrugated Nailers**

WS2513	49
WS1315	49

## 13

**Deco Nailer**

ZN1170	51
ZN-12	51

## 14

**Carton Closing Stapler**

HB3515	53
HB3518	53
ADCS-19	53
ADCS-22	53

## 15

**Nails**

Coil Nails Series	55
C-Rings Series	57
Clips Series	57
12J Series	57
Headless Pin Series	58
71 Series	59
80 Series	59
50 Series	59
N Series	60
14 Series	60
92 Series	60
90/K Series	61
P Series	61
F Brad Series	62
T Brad Series	62
Carton Staples Series	62

## 16

**Accessories** 63



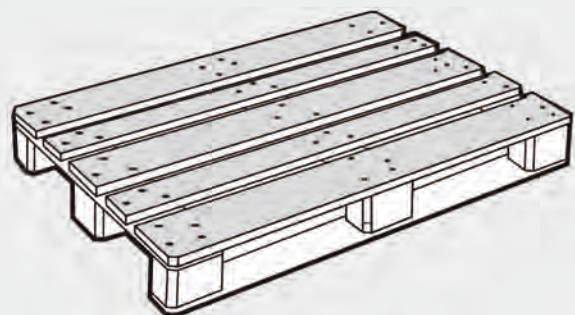

APPLICATIONS	TOOL SERIES	MODEL	
Pallets Crates/Wood Case Packaging	Coil Nailer	CN55	
		CN65B	
		CN70B	
		CN70E CN70DS	
		CN80B	
		CN90	
		CN100B CN100 CN100EPAL	
		CN130	
		Nail Puller	T50SC-B NP55 NP70
		Heavy Wire Stapler	N851F MT-N851-H N851-L
Packaging	Carton Closing Stapler	PW2638-L 1440 1450	
		Strip Nailer	SF13021
		HB3515 HB3518	
		ADCS-19 ADCS-22	

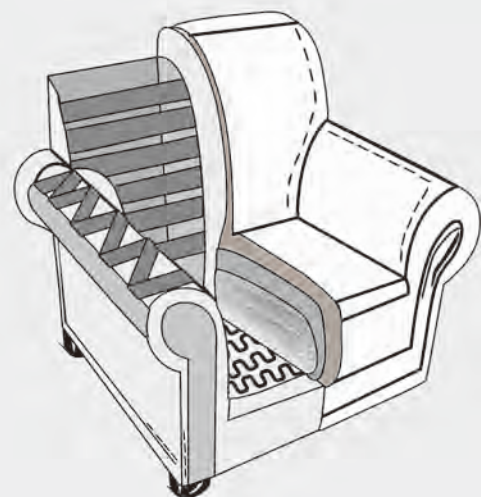

APPLICATIONS	TOOL SERIES	MODEL	
Furniture Cabinets Bedding	Fine Wire Stapler	MT7116 7116B	
		MT8016 8016B 8016F2	
		1022J	
		422J	
		MT5016 MTP5016	
		MT1416 1416B	
		MT432KLM MT440KLM	
		Medium Wire Stapler	440KB
		9240B	
		635TR	
Cabinets	Headless Pinner Nailer	Heavy Wire Stapler	
		N851F MT-N851-H N851-L	
		PW2638-L	
		Coil Nailer	CN55
		Deco Nailer	ZN1400 ZN-12
		Brad Nailer	MTF32 F32 F32D F50C F50G
		T64A T50MA FST50	
		P625B MP630B	
		MP635B MP650B	
		Mini Brad Pinner	MT840 MT850

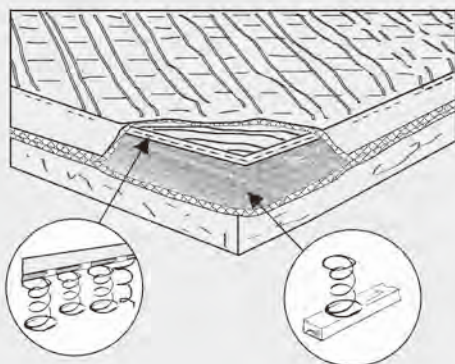

APPLICATIONS	TOOL SERIES	MODEL	
Spring Mattress	C-Ring Plier	SC7C	
		SC7E	
		SC760C SC77XE	
Car Seat	Clipping Tool	M66C M65C M46C M45C	
		M66L M66LB M65LB M46LB M66L2	
		Stapling Plier	P88U P88U-B
		Fine Wire Stapler	MT7116 7116B 7116C MT7116S
			MT8016 8016B 8016F2 MT8016S
	1022J		
	422J		
	MT5016S		
	MT8416 MT8416S		
	MT1416 MT1416S 1416B		

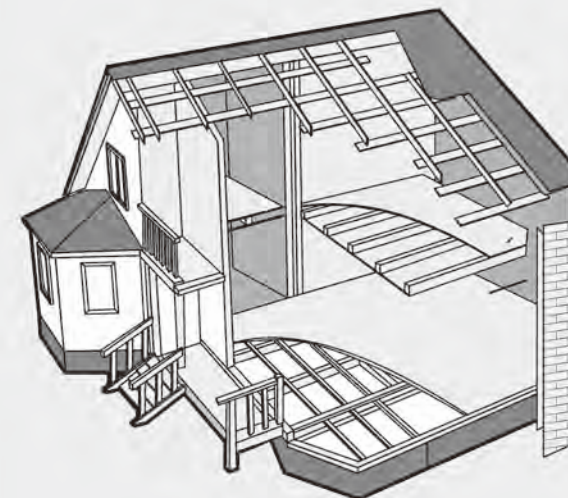

APPLICATIONS	TOOL SERIES	MODEL	
Flooring Decking Siding Sheathing Fencing	Flooring Nailer	MFS50	
		Construction Coil Nailer	CN452S CN45R CN65S
		Coil Nailer	CN55
		Roofing Nailer	CN70B CN70E
		Heavy Wire Stapler	CN80B SN2183FA SN3483F
		Concrete and Steel Nailer	CN90
		CS3025 MTC3040L	
		MT7116 7116B 7116C	
		MT8016 8016B 8016F2	
		1022J	
Windows Door	Fine Wire Stapler	422J	
		MT5016 MTP5016	
		MT1416 1416B	
		MT432KLM MT440KLM	
		Medium Wire Stapler	440KB
		9240B	
		635TR	
		Heavy Wire Stapler	MT-N851-H N851-L 1440 1450
		N851F PW2638-L	
		Brad Nailer	MTF32 F32 F32D F50C
Interior Decoration	Headless Pinner Nailer	MP622B MP630B	
		MP635B MP650B	
		Mini Brad Pinner	MT840 MT850

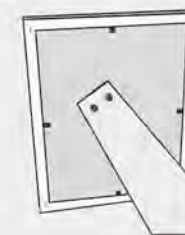

APPLICATIONS	TOOL SERIES	MODEL	
Picture Frame	Flex Point Tacker	HM515	
		P515	
		V-Nailer	V1015B
		Headless Pinner Nailer	MP622B MP630B
		MP635B MP650B	
		Mini Brad Pinner	MT840 MT850



# CONSTRUCTION NAILER

## 15° CN45R CONSTRUCTION NAILER 1-3/4" Roofing Nailer

### FEATURES

- Powerful for heavy-duty applications
- Durable driver and bumper for long life
- Single and rapid firing switchable
- Depth control with a simple adjustable knob
- Bump firing trigger for high speed operation

### APPLICATIONS

Roofing

### FASTENER

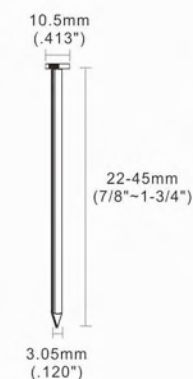

Weight	Length	Width	Height	Capacity	Air Inlet	Trigger	Operating Pressure	Type: Wire Collated Roofing Nail
2.6kg/5.7lbs	250mm/9.84"	118mm/4.65"	275mm/10.83"	120pcs	3/8"NPT	Contact	70~120psi	Nail Pitch: 8.0mm(.315")



**Trigger**  
Available to change intermittent operation from continuous operation



**Nail Plate**  
According to loading different nails length, the nail plate has three height sections for adjustment



**Nail Outlet**  
With an adjuster to adjust the nailing depth



**Muzzle**  
Two pieces of tungsten steel with high hardness are welded at the muzzle to make the muzzle more wear-resistant and durable





**15° CONSTRUCTION NAILER**  
**CN65S**  
**2-1/2" Coil Siding Nailer**



**Trigger**  
 Ability to switch between single-sequential and contact actuation trigger

**360° Adjustable Exhaust**  
 The 360° adjustable exhaust directs air away from the user and releases pressure

**Toolless Depth Adjust**  
 With an adjuster to adjust the nailing depth

**FEATURES**

- Powerful for heavy-duty applications
- Durable driver and bumper for long life
- Single and rapid firing swithable
- Depth control with simple adjustable knob
- Bump firing trigger for high speed operation

**APPLICATIONS**

Siding / Fencing / Sheathing / Framing

**FASTENER**

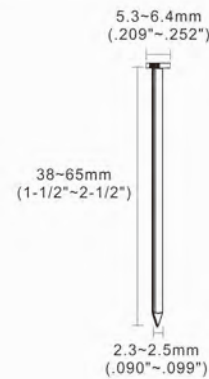

**Type:** Wire Collated Coil Nails  
**Nail Pitch:** 6.8mm (.268")  
**Shank Type:** Smooth, Screw & Ring

Weight	Length	Width	Height	Capacity	Air Inlet	Trigger	Operating Pressure
2.3kg/5.1lbs	290mm/11.42"	130mm/5.12"	300mm/11.81"	200-300pcs	3/8"NPT	Contact	70-120psi

**15° CONSTRUCTION NAILER**  
**CN83F**  
**3-1/4" Coil Framing Nailer**



**FEATURES**

- Switchable firing mode
- Light weight & well-balanced
- Adjustable depth control

**APPLICATIONS**

Framing / Decking / Subflooring / Pallets / Crates

**FASTENER**

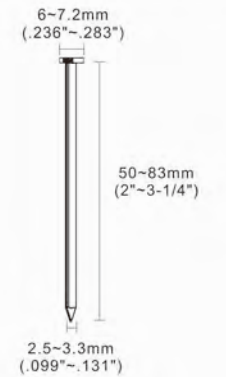

**Type:** Wire Collated Coil Nails  
**Nail Pitch:** 8mm (.315")  
**Shank Type:** Smooth, Screw & Ring

Weight	Length	Width	Height	Capacity	Air Inlet	Trigger	Operating Pressure
4.1kg/9.0lbs	315mm/12.40"	136mm/5.35"	350mm/13.78"	200-300pcs	3/8"NPT	Contact	70-120psi

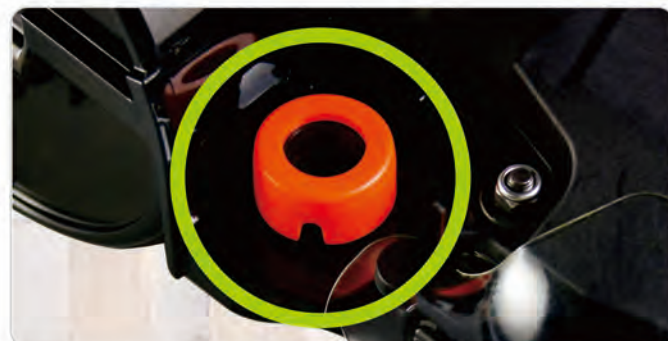

**Nose Cap**  
 Protects material from accidental marks

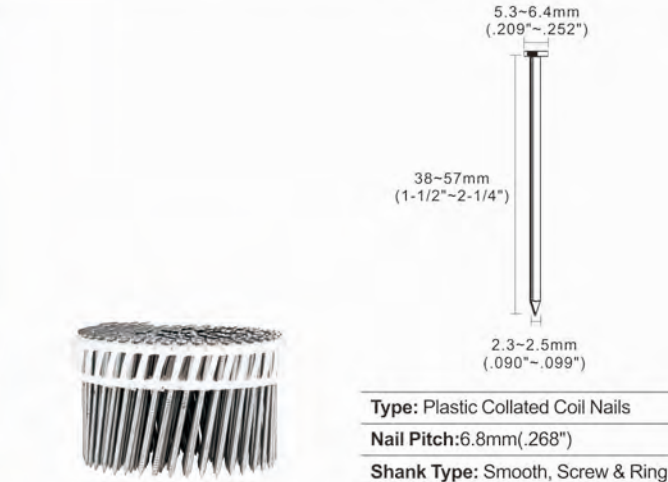

**Type:** Plastic Collated Coil Nails  
**Nail Pitch:** 6.8mm (.268")  
**Shank Type:** Smooth, Screw & Ring



**Easy Load Magazine**  
 Side load, tilt bottom magazine for fast and easy reloads



**Adjuster**  
 Depth control with a simple knob



**Trigger**  
 Ability to switch between sequential and contact actuation trigger



**Hook**  
 Adjustment for hook direction



**15° CONSTRUCTION NAILER**  
**CN452S**  
**2" Coil Nailer**

**FEATURES**

- Switchable firing mode
- 360° exhaust deflector
- Light weight & well-balanced
- Adjustable depth control
- No-mar tip

**APPLICATIONS**

Siding / Decking / Fencing / Sheathing

**FASTENER**



**Type:** Wire & Plastic Collated / Coil Nails  
**Nail Pitch:** 6mm (.236")  
**Shank Type:** Smooth, Screw & Ring

Weight	Length	Width	Height	Capacity	Air Inlet	Trigger	Operating Pressure
1.86kg/4.1lbs	287mm/11.30"	110mm/4.33"	300mm/11.81"	300pcs	1/4"NPT	Contact	70-100psi





## FRAMING NAILER

### APPLICATIONS

- Floor and wood framing
- Truss build-up, Window build-up
- Subflooring and roof decking
- Wood sheathing
- Mobile house and modular housing construction

## 21° SN2183FA FRAMING NAILER 3-1/4" Framing Nailer



### FEATURES

- Powerful for heavy-duty applications
- Durable driver and bumper for long life
- Single and rapid firing switchable
- Well-balanced comfort rubber grip
- Accurate nose, minimizing nail jam
- Bump firing trigger for high speed operation

### FASTENER



Type: Plastic Collated Strip Nails  
Full Head Nails  
Shank Type: Smooth, Screw & Ring

Model	Weight	Length	Width	Height	Capacity	Air Inlet	Trigger	Operating pressure
SN2183FA	4.1kg/9.0lbs	368mm/14.49"	161mm/6.34"	479mm/18.86"	50-70pcs	3/8"NPT	Contact	70-120psi
SN2183F	4.1kg/9.0lbs	368mm/14.49"	161mm/6.34"	479mm/18.86"	50-70pcs	3/8"NPT	Contact	70-120psi



**Adjuster**  
Depth control with a simple knob



**Trigger**  
Ability to switch between single-sequential and contact actuation trigger



**Magazine**  
Light weight with aluminum magazine, 4pcs nails left protection mechanism

34°  
FRAMING NAILER

## SN3483F 3-1/4" Framing Nailer



### FEATURES

- Powerful for heavy-duty applications
- Fits most clipped head paper strip collected nails
- Well-balanced comfort rubber grip
- Accurate nose, minimizing nail jam
- Bump firing trigger for high speed operation
- Single and rapid firing switchable

Weight	Length	Width	Height	Capacity	Air Inlet	Trigger	Operating Pressure
4.1kg/9.0lbs	505mm/19.88"	165mm/6.50"	370mm/14.57"	70-90pcs	3/8"NPT	Contact	70-120psi

### FASTENER



Type: Paper Collated Strip Nails  
Clipped and Offset Round Nails  
Shank Type: Smooth, Screw & Ring

34°  
FRAMING NAILER

## DA6434 2-1/2" Finish Nailer



### FEATURES

- Integrated air duster for dust and debris cleaning
- Single and rapid firing switchable
- Depth control with a simple adjustable knob
- Light weight magazine to reduce fatigue
- Quick jams release muzzle

Weight	Length	Width	Height	Capacity	Air Inlet	Trigger	Operating pressure
1.90kg/4.20lbs	344mm/13.54"	82mm/3.23"	304mm/11.97"	100pcs	3/8"NPT	Contact	70-120psi

### FASTENER

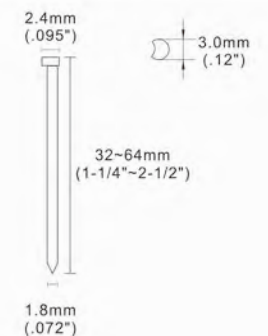

Type: Tape Collated DA Nails  
Shank Type: Smooth

21°  
FRAMING NAILER

## SF13021 5-1/8" Strip Nailer



### FEATURES

- Powerful for heavy-duty applications
- Well-balanced
- Rubber comfort grip
- Durable driver and bumper for long life
- Second handle to reduce fatigue

Weight	Length	Width	Height	Capacity	Air Inlet	Trigger	Operating pressure
6.76kg/14.9lbs	528mm/20.78"	153mm/6.02"	463mm/18.22"	30pcs	3/8"NPT	Contact	100-120psi

### FASTENER

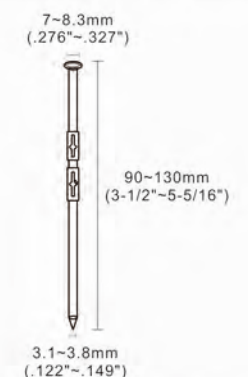

Type: Plastic-collated strip nails  
Full round head  
Shank Type: Smooth, Screw & Ring



# COIL NAILER



15°  
COIL NAILER

## CN38 1-1/2" Coil Nailer

### FEATURES

- Powerful for heavy-duty applications
- Well-balanced, comfort rubber grip
- Bump firing trigger for high speed operation
- Durable driver and bumper for long life
- Accurate nose, minimizing nail jam

### APPLICATIONS

Pallets / Crates / Wood case / Sheathing / Siding / Fencing / Decking

### FASTENER

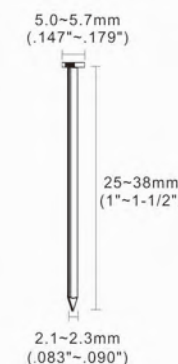

Weight	Length	Width	Height	Capacity	Air Inlet	Trigger	Operating pressure
2.05kg/4.52lbs	285mm/11.22"	135mm/5.31"	270mm/10.63"	400pcs	1/4"NPT	Contact	70-100psi

Type: Wire Collated Coil Nails  
Nail Pitch: 6.8mm(.267")  
Shank Type: Smooth, Screw & Ring

## 15° CONSTRUCTION NAILER CN55 2-1/4" Coil Nailer

### FEATURES

- Powerful for heavy-duty applications
- Well-balanced, comfort rubber grip
- Bump firing trigger for high speed operation
- Durable driver and bumper for long life
- Accurate nose, minimizing nail jam

### APPLICATIONS

Pallets / Crates / Wood Cases / Packaging

### FASTENER

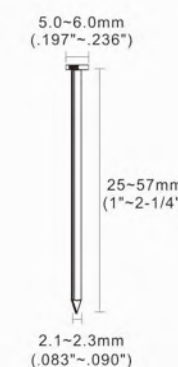

Weight	Length	Width	Height	Capacity	Air Inlet	Trigger	Operating Pressure
2.75kg/6.06lbs	270mm/10.62"	131mm/5.15"	283mm/11.14"	300-400pcs	1/4"NPT	Contact	70-120psi

Type: Wire Collated Coil Nails  
Nail Pitch: 6.8mm(.267")  
Shank Type: Smooth, Screw & Ring



360° exhaust deflector



Large capacity nail box



Durable driver and bumper





15° COIL NAILER

## CN65B 2-1/2" Coil Nailer

### FEATURES

- 360° exhaust deflector
- Bump firing trigger for high speed operation
- Light weight and well-balanced
- Durable driver and bumper for long life

### APPLICATIONS

Decking / Subflooring / Sheathing / Pallets

### FASTENER



Type: Wire Collated Coil Nails  
Nail Pitch: 8.0mm (.315")  
Shank Type: Smooth, Screw & Ring

Weight	Length	Width	Height	Capacity	Air Inlet	Trigger	Operating Pressure
2.92kg/6.44lbs	310mm/12.20"	130mm/5.11"	328mm/12.91"	300pcs	1/4"NPT	Contact	70~120psi



15° COIL NAILER

## CN80B 3-1/4" Coil Nailer

### FEATURES

- Powerful for heavy-duty applications
- Well-balanced, comfort rubber grip
- Bump firing trigger for high speed operation
- Durable driver and bumper for long life
- Accurate nose, minimizing nail jam

### APPLICATIONS

Pallets / Crates / Wood Cases / Packaging

### FASTENER



Type: Wire Collated Coil Nails  
Nail Pitch: 8mm (.315")  
Shank Type: Smooth, Screw & Ring

Weight	Length	Width	Height	Capacity	Air Inlet	Trigger	Operating Pressure
4.02kg/8.86lbs	347mm/13.66"	137mm/5.39"	348mm/13.70"	225~300pcs	1/4"NPT	Contact	85~120psi

## 15° CN70B 2-3/4" Coil Nailer



### FEATURES

- Powerful for heavy-duty applications
- Well-balanced, comfort rubber grip
- Bump firing trigger for high speed operation
- Durable driver and bumper for long life
- Accurate nose, minimizing nail jam

### APPLICATIONS

Pallets / Crates / Wood Cases / Packaging

### FASTENER

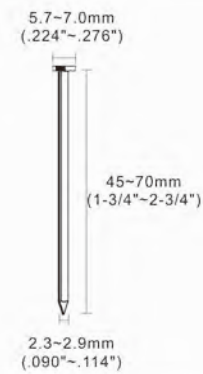

Type: Wire Collated Coil Nails  
Nail Pitch: 8mm (.315")  
Shank Type: Smooth, Screw & Ring

Weight	Length	Width	Height	Capacity	Air Inlet	Trigger	Operating Pressure
3.84kg/8.47lbs	336mm/13.22"	143mm/5.62"	318mm/12.51"	225~300pcs	1/4"NPT	Contact	70~120psi

## 15° CN70E/CN80E 2-3/4" Coil Nailer



CN80E



### FEATURES

- Tool for automatic pallet machine
- Powerful for heavy-duty applications
- Rapid firing trigger for high speed operation
- Durable driver and bumper for long life
- Accurate nose to minimize nail jam

### APPLICATIONS

Pallets

### FASTENER

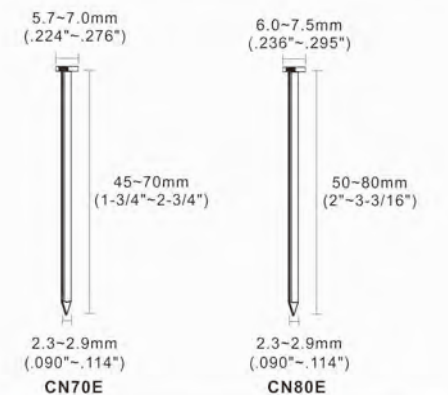

Model	Weight	Length	Width	Height	Capacity	Air Inlet	Trigger	Operating pressure	Type: Wire Collated Coil Nails
CN70E	3.05kg/6.72lbs	338mm/13.31"	112mm/4.40"	318mm/12.51"	/	1/4"NPT	Remote Contact	70~120psi	Nail Pitch: 8mm (.315")
CN80E	3.38kg/7.45lbs	347mm/13.66"	137mm/5.39"	348mm/13.70"	/	1/4"NPT	Remote Contact	85~120psi	Shank Type: Smooth, Screw & Ring



**Nail Box**  
Large capacity for easy loading and unloading



**Driver Set**  
High intensity steel, for stronger force and more durability



**Sensitive Trigger**  
Available in continuously nailing by pressing the trigger and hitting the work items





**15° COIL NAILER** **CN70DS**  
**2-3/4" Coil Nailer**



**FEATURES**

- Powerful for heavy-duty applications
- Both hands requested for actuation to minimize accident
- Bump firing trigger for high speed operation
- Durable driver and bumper for long life
- Accurate nose to minimize nail jam

**APPLICATIONS**

Pallets / Crates / Wood case

**FASTENER**

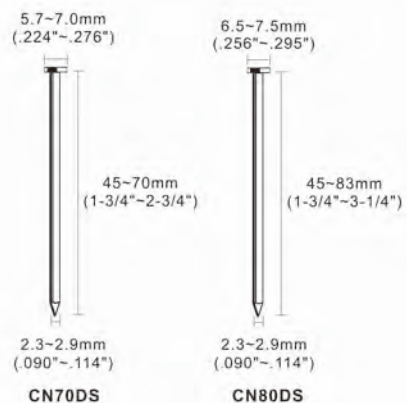

Model	Weight	Length	Width	Height	Capacity	Air Inlet	Trigger	Operating pressure
CN70DS	4.0kg/8.86lbs	376mm/14.80"	133mm/5.23"	318mm/12.51"	225-300pcs	1/4"NPT	Contact	70-120psi
CN80DS	4.67kg/10.30lbs	347mm/13.66"	137mm/5.39"	348mm/13.70"	225-300pcs	1/4"NPT	Contact	85-120psi
CN100DS	5.80kg/12.79lbs	370mm/14.50"	159mm/6.25"	420mm/16.53"	225-300pcs	3/8"NPT	Contact	85-120psi

Type: Wire Collated Coil Nails

Nail Pitch: 8mm(.315")

Shank Type: Smooth, Screw & Ring

**15° COIL NAILER** **CN90**  
**3-1/2" Coil Nailer**



**FEATURES**

- Powerful for heavy-duty applications
- Well-balanced, comfort rubber grip
- Bump firing trigger for high speed operation
- Durable driver and bumper for long life
- Accurate nose, minimizing nail jam

**APPLICATIONS**

Pallets / Crates / Wood Cases / Packaging

**FASTENER**

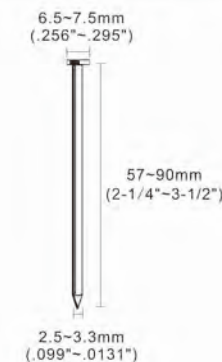

Type: Wire Collated Coil Nails

Nail Pitch: 8mm(.315")

Shank Type: Smooth, Screw & Ring

Weight	Length	Width	Height	Capacity	Air Inlet	Trigger	Operating Pressure
4.13kg/9.11lbs	385mm/15.15"	137mm/5.39"	365mm/14.37"	225-300pcs	3/8"NPT	Contact	85-120psi

**15° COIL NAILER** **CN100B**  
**4" Coil Nailer**



**FEATURES**

- Powerful for heavy-duty applications
- Well-balanced when hung on balancer
- Rubber comfort grip
- Downward directional exhaust
- Durable driver and bumper for long life

**APPLICATIONS**

Pallets / Crates / Wood Cases / Packaging

**FASTENER**

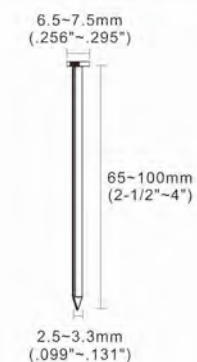

Type: Wire Collated Coil Nails

Nail Pitch: 8mm(.315")

Shank Type: Smooth, Screw & Ring

Weight	Length	Width	Height	Capacity	Air Inlet	Trigger	Operating Pressure
5.67kg/12.5lbs	370mm/14.56"	159mm/6.25"	420mm/16.53"	225-300pcs	3/8"NPT	Contact	85-120psi

**15° COIL NAILER** **CN100**  
**4" Coil Nailer**



**FEATURES**

- Powerful for heavy-duty applications
- Well-balanced when hung on balancer
- Rubber comfort grip
- Downward directional exhaust
- Durable driver and bumper for long life

**APPLICATIONS**

Pallets / Crates / Wood case / Packaging / Decking / Sheathing

**FASTENER**

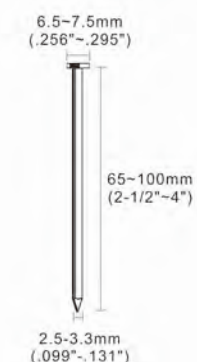

Type: Wire Collated Coil Nails

Nail Pitch: 8mm(.315")

Shank Type: Smooth, Screw & Ring

Weight	Length	Width	Height	Capacity	Air Inlet	Trigger	Operating pressure
5.28kg/11.64lbs	405mm/15.94"	143mm/5.62"	403mm/15.86"	225-300pcs	3/8"NPT	Contact	85-120psi



**CN80DS**



**CN100DS**

**FASTENER**

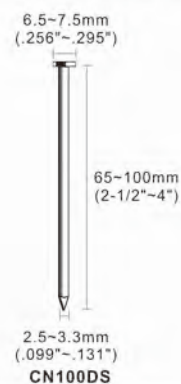

Type: Wire Collated Coil Nails

Nail Pitch: 8mm(.315")

Shank Type: Smooth, Screw & Ring





15°  
COIL NAILER

## CN100EPAL 3-1/2" Coil Nailer

### FEATURES

- Drives EPAL Coil nails from 70-90mm
- Powerful for heavy-duty applications
- Well-balanced when hung on balancer
- Rubber comfort grip
- Downward directional exhaust
- Durable driver and bumper for long life

### APPLICATIONS

EPAL Pallets/ Heavy-duty pallets / Packaging

### FASTENER

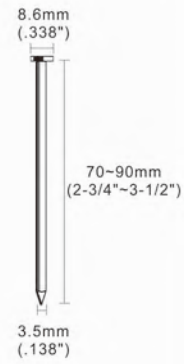

Type: Wire Collated Coil Nails  
Nail Pitch: 8mm (.315")  
Shank Type: Smooth, Screw & Ring

Weight	Length	Width	Height	Capacity	Air Inlet	Trigger	Operating pressure
5.8kg/12.8lbs	457mm/17.99"	156mm/6.14"	336mm/13.22"	225-300pcs	3/8"NPT	Contact	115-145psi



15°  
COIL NAILER

## CN130 5-1/8" Coil Nailer

### FEATURES

- Powerful for heavy-duty applications
- Well-balanced when hung on balancer
- Rubber comfort grip
- Downward directional exhaust
- Durable driver and bumper for long life

### APPLICATIONS

Pallets / Crates / Wood case /  
Packaging / Framing

### FASTENER

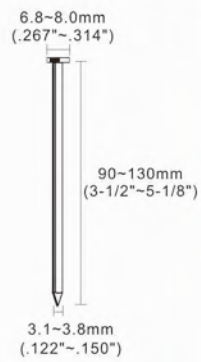

Type: Wire Collated Coil Nails  
Nail Pitch: 10.5mm (.413")  
Shank Type: Smooth, Screw & Ring

Weight	Length	Width	Height	Capacity	Air Inlet	Trigger	Operating pressure
6.51kg/14.35lbs	370mm/14.56"	165mm/6.49"	479mm/18.85"	120-225pcs	3/8"NPT	Contact	115-145psi



# NAIL REMOVING







## T50SC-B

### Nail Puller

#### FEATURES

- Light weight & well-balanced
- Rubber comfort grip
- Durable driver and bumper for long life
- Powerful for heavy-duty applications

#### APPLICATIONS

Pallets / Packaging / Crates / Wood

Weight	Length	Width	Height	Capacity	Air Inlet	Trigger	Operating pressure
1.18kg/2.60lbs	282mm/11.10"	62mm/2.44"	228mm/8.97"	/	1/4"NPT	Trigger	60~100psi

#### FASTENER



2~4.5mm  
(.079"~1.77")

1. This list is only for your reference.
2. You should chose one larger model if the wood is hard

Thickness of Wood: 15~25mm

Length of Nail: 60~85mm



## NP45

### Nail Puller

#### FEATURES

- Light weight & well-balanced
- Rubber comfort grip
- Durable driver and bumper for long life
- Powerful for heavy-duty applications

#### APPLICATIONS

Pallets / Packaging / Crates / Wood

Weight	Length	Width	Height	Capacity	Air Inlet	Trigger	Operating pressure
1.11kg/2.45lbs	311mm/12.24"	73mm/2.87"	227mm/8.94"	/	1/4"NPT	Trigger	60~100psi

#### FASTENER



2~4.5mm  
(.079"~1.77")

1. This list is only for your reference.
2. You should chose one larger model if the wood is hard

Thickness of Wood: 15~25mm

Length of Nail: 60~85mm



## NP55

### Nail Puller

#### FEATURES

- Light weight & well-balanced
- Rubber comfort grip
- Durable driver and bumper for long life
- Powerful for heavy-duty applications

#### APPLICATIONS

Pallets / Packaging / Crates / Wood

Weight	Length	Width	Height	Capacity	Air Inlet	Trigger	Operating pressure
2.0kg/4.41lbs	293mm/11.53"	99mm/3.90"	287mm/11.30"	/	1/4"NPT	Trigger	70~120psi

#### FASTENER



2~5mm  
(.079"~.197")

1. This list is only for your reference.
2. You should chose one larger model if the wood is hard

Thickness of Wood: 25~40mm

Length of Nail: 85~130mm



## NP70

### Nail Puller

#### FEATURES

- Light weight & well-balanced
- Rubber comfort grip
- Durable driver and bumper for long life
- Powerful for heavy-duty applications

#### APPLICATIONS

Pallets / Packaging / Crates / Wood

Weight	Length	Width	Height	Capacity	Air Inlet	Trigger	Operating pressure
2.58kg/5.69lbs	336mm/13.23"	112mm/4.41"	303mm/11.93"	/	1/4"NPT	Trigger	70~120psi

#### FASTENER



2~5mm  
(.079"~.197")

1. This list is only for your reference.
2. You should chose one larger model if the wood is hard

Thickness of Wood: 35~50mm

Length of Nail: 85~140mm

# MATTRESS & CAR SEAT





**17 GA C-RING PLIER** **SC712**  
**5/16" C-Ring Plier**



- FEATURES**
- Well-balanced, ergonomically designed
  - Shorter magazine body, lighter and more flexible
  - Rubber comfort grip
  - Easily converted to right or left hand operation

**APPLICATIONS**  
Wire Cage / Horticulture / Bag Closure

**FASTENER**

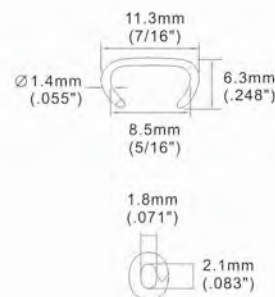

Weight	Length	Width	Height	Capacity	Air Inlet	Trigger	Operating Pressure
1.56kg/3.44lbs	270mm/10.63"	94mm/3.70"	210mm/8.27"	100pcs	1/4"NPT	Trigger	70~100psi

**Type:** Tape Collated C-Ring  
**Gauge size:** 17GA  
**Material:** Galvanized, Stainless



Better sealing with one-piece front valve set



More durable jaw by line cutting



Shorter magazine body, lighter and more flexible

**16 GA C-RING PLIER** **SC760C**  
**1/2" C-Ring Plier**



- FEATURES**
- Well-balanced, ergonomically designed
  - Large capacity long magazine
  - Rubber comfort grip
  - Easily converted to right or left hand operation

**APPLICATIONS**  
Wire Cage / Car Seat / Spring Mattress / Bag Closure

**FASTENER**

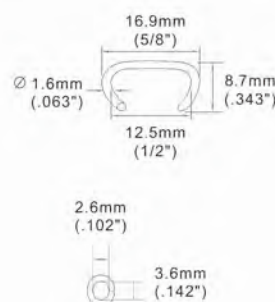

Weight	Length	Width	Height	Capacity	Air Inlet	Trigger	Operating Pressure
1.57kg/3.46lbs	335mm/13.19"	92mm/3.62"	210mm/8.27"	100-150pcs	1/4"NPT	Trigger	70~100psi

**Type:** Tape Collated C-Ring  
**Gauge size:** 16GA  
**Material:** Galvanized, Stainless

**15 GA C-RING PLIER** **SC7C**  
**3/4" C-Ring Plier**



- FEATURES**
- Well-balanced, ergonomically designed
  - Large capacity long magazine
  - Rubber comfort grip
  - Easily converted to right or left hand operation

**APPLICATIONS**  
Wire Cage / Car Seat / Spring Mattress / Bag Closure

**FASTENER**

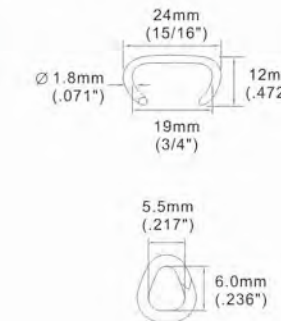

Weight	Length	Width	Height	Capacity	Air Inlet	Trigger	Operating Pressure
1.67kg/3.68lbs	335mm/13.19"	93mm/3.66"	210mm/8.27"	130pcs	1/4"NPT	Trigger	70~100psi

**Type:** Tape Collated C-Ring  
**Gauge size:** 15GA  
**Material:** Galvanized, Stainless

**15 GA C-RING PLIER** **SC7E**  
**3/4" C-Ring Plier**



- FEATURES**
- Well-balanced, ergonomically designed
  - Large capacity long magazine
  - Rubber comfort grip
  - Easily converted to right or left hand operation

**APPLICATIONS**  
Wire Cage / Car Seat / Spring Mattress / Bag Closure

**FASTENER**

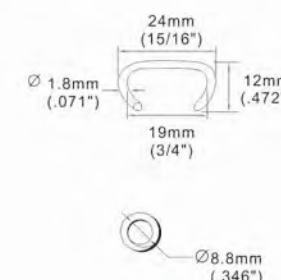

Weight	Length	Width	Height	Capacity	Air Inlet	Trigger	Operating Pressure
1.67kg/3.68lbs	351mm/13.82"	92mm/3.62"	210mm/8.27"	130pcs	1/4"NPT	Trigger	70~100psi

**Type:** Tape Collated C-Ring  
**Gauge size:** 15GA  
**Material:** Galvanized, Stainless

**15 GA C-RING PLIER** **SC77XE**  
**3/4" C-Ring Plier**  
**Exrta Extended nose**



- FEATURES**
- Well-balanced, ergonomically designed
  - Large capacity long magazine
  - Rubber comfort grip
  - Easily converted to right or left hand operation

**APPLICATIONS**  
Wire Cage / Car Seat / Spring Mattress / Bag Closure

**FASTENER**

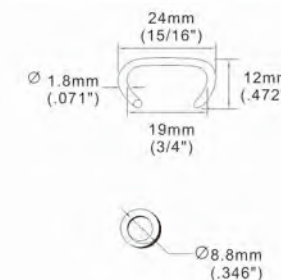

Weight	Length	Width	Height	Capacity	Air Inlet	Trigger	Operating pressure
1.86kg/4.10lbs	378mm/14.88"	88mm/3.46"	216mm/8.50"	100pcs	1/4"NPT	Trigger	70~100psi

**Type:** Tape collated C-Ring  
**Gauge size:** 15GA  
**Material:** Galvanized, stainless



# CLIPPING TOOLS

14 GA  
C-RING  
PLIER

## MTC560

### 1-1/2" C-Ring Plier

#### FEATURES

- Well-balanced, ergonomically designed
- Large capacity long magazine
- Rubber comfort grip
- Can be easily converted to right or left hand operation

#### APPLICATIONS

Wire Cage / Car Seat / Spring Mattress / Bag Closure

#### FASTENER

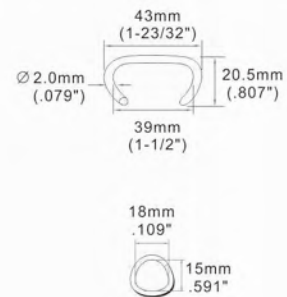

Type: Tape Collated C-Ring

Gauge size: 14GA

Material: Galvanized, Stainless



Weight	Length	Width	Height	Capacity	Air Inlet	Trigger	Operating Pressure
2.8kg/6.17lbs	422mm/16.61"	131mm/5.16"	243mm/9.57"	125pcs	1/4"NPT	Trigger	70~120psi

14 GA  
C-RING  
PLIER

## MTC600

### 1-9/16" C-Ring Plier

#### FEATURES

- Well-balanced, ergonomically designed
- Large capacity long magazine
- Rubber comfort grip
- Can be easily converted to right or left hand operation

#### APPLICATIONS

Wire Cage / Spring Mattress / Bag Closure

#### FASTENER

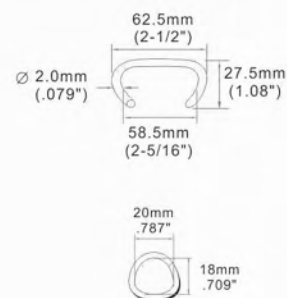

Type: Tape collated C-Ring

Gauge size: 14GA

Material: Galvanized, stainless



Weight	Length	Width	Height	Capacity	Air Inlet	Trigger	Operating pressure
3.5kg/7.72lbs	435mm/17.13"	152mm/5.98"	273mm/10.75"	125pcs	1/4"NPT	Trigger	70~120psi

11 GA  
C-RING  
PLIER

## MTHC45

### 1-1/2" Manual C-Ring Plier

#### FEATURES

- Well-balanced, ergonomically designed
- Convenient to use, no compressed air is needed
- Rubber comfort grip

#### APPLICATIONS

Gabion / Wire Cage / Fencing

#### FASTENER

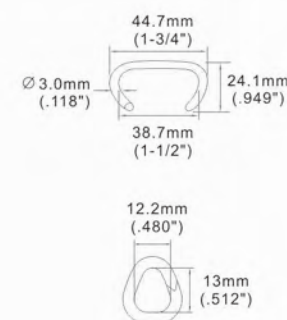

Type: Tape Collated C-Ring

Gauge size: 11GA

Material: Galvanized, Stainless



Weight	Length	Width	Height	Capacity	Air Inlet	Trigger	Operating Pressure
4.31kg/9.50lbs	673mm/26.49"	125mm/4.92"	165mm/6.49"	45pcs	/	Manual	/

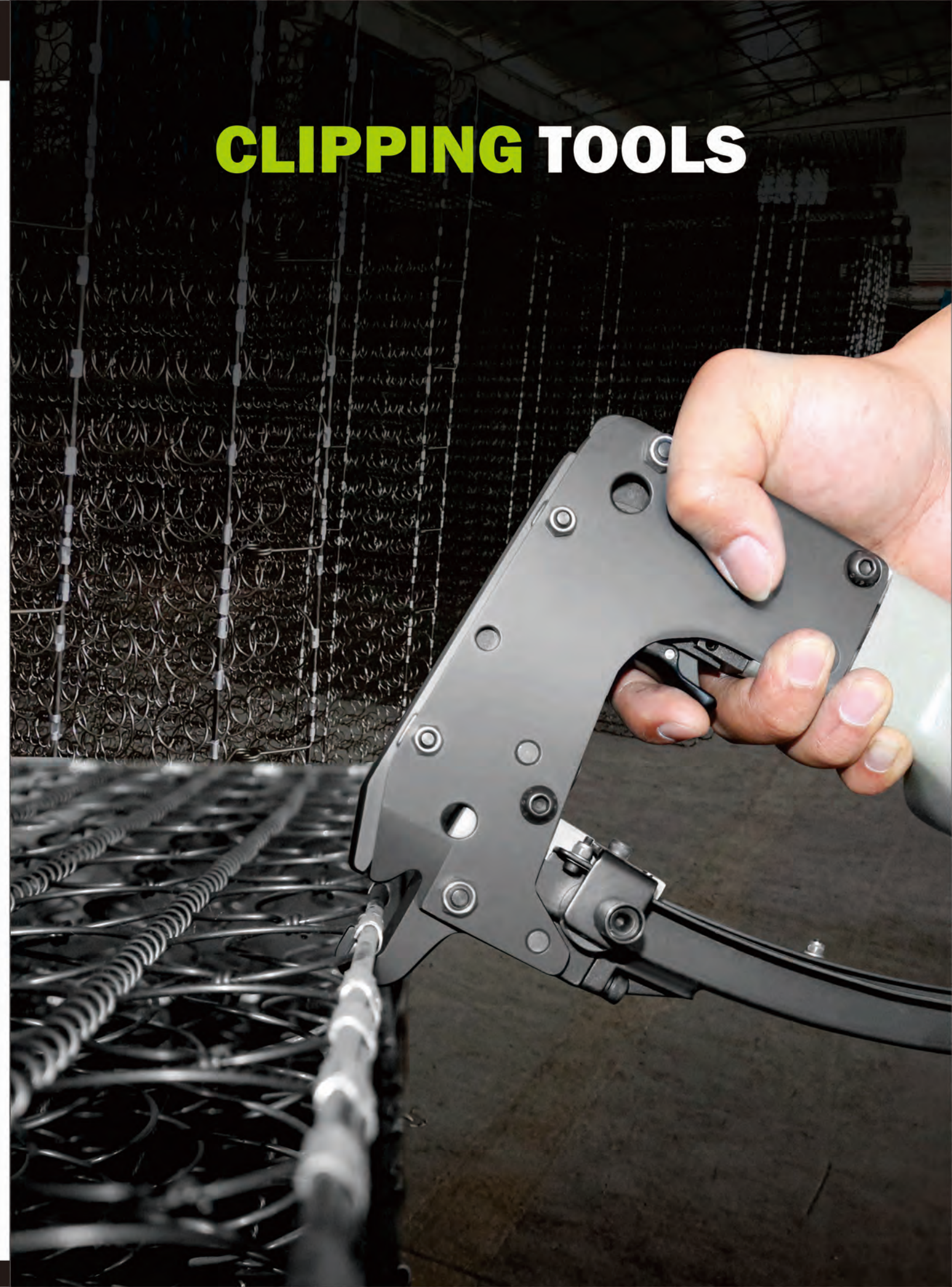



# M66C Clipper



### FEATURES

- Powerful motor for high speed operation
- Die-casting housing for lighter weight
- Durable blade and anvil for long life
- Higher efficiency for more sensitive trigger

### APPLICATIONS

Wire Cage / Spring Mattress / Car Seat

### FASTENER

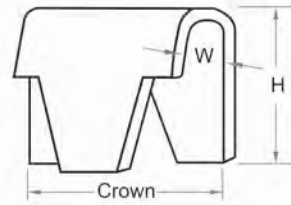

Model	Weight	Length	Width	Height	Capacity	Air Inlet	Trigger	Operating pressure	W	H	Crown	Thickness	Type	
M66C	3.0kg/6.61lbs	405mm/15.94"	99mm/3.90"	225mm/8.86"	40pcs	1/4"NPT	Trigger	70~120psi	CL-3	6.2	12.3	22	0.8	Strip
M65C	3.0kg/6.61lbs	405mm/15.94"	99mm/3.90"	225mm/8.86"	50pcs	1/4"NPT	Trigger	70~120psi	CL-4	6.2	14.1	22	0.8	Strip
M46C	3.0kg/6.61lbs	405mm/15.94"	99mm/3.90"	225mm/8.86"	40pcs	1/4"NPT	Trigger	70~120psi	CL-5	6.2	15.5	19	0.8	Strip
M45C	3.0kg/6.61lbs	405mm/15.94"	99mm/3.90"	225mm/8.86"	50pcs	1/4"NPT	Trigger	70~120psi	CL-71	6.2	12.7	19	0.8	Strip
									CL-72	6.2	14.1	19	0.8	Strip

# M66LB Clipper



### FEATURES

- Well-balanced, ergonomically designed
- Powerful motor for high speed operation
- Durable blade and anvil for long life
- Composite plastic magazine

### APPLICATIONS

Wire Cage / Spring Mattress / Car Seat

### FASTENER

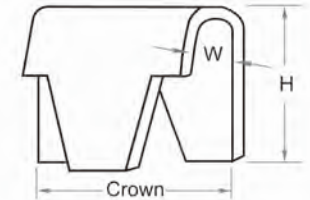

Model	Weight	Length	Width	Height	Capacity	Air Inlet	Trigger	Operating pressure	W	H	Crown	Thickness	Type	
M66LB	2.28kg/5.03lbs	426mm/16.77"	102mm/4.02"	201mm/7.91"	40pcs	1/4"NPT	Trigger	70~100psi	CL-3	6.2	12.3	22	0.8	Strip
M66L2	2.80kg/6.17lbs	365mm/14.37"	118mm/4.65"	195mm/7.68"	40pcs	1/4"NPT	Trigger	70~100psi	CL-4	6.2	14.1	22	0.8	Strip
M66L	2.25kg/4.96lbs	426mm/16.77"	102mm/4.02"	201mm/7.91"	40pcs	1/4"NPT	Trigger	70~100psi	CL-5	6.2	15.5	19	0.8	Strip
M65LB	2.25kg/4.96lbs	426mm/16.77"	102mm/4.02"	201mm/7.91"	40pcs	1/4"NPT	Trigger	70~100psi	CL-71	6.2	12.7	19	0.8	Strip
M46LB	2.25kg/4.96lbs	426mm/16.77"	102mm/4.02"	201mm/7.91"	40pcs	1/4"NPT	Trigger	70~100psi	CL-72	6.2	14.1	19	0.8	Strip

### M65C

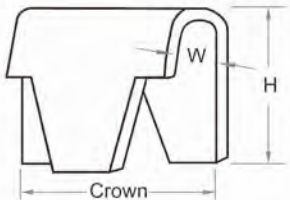

W	H	Crown	Thickness	Type	
CL-23	4.8	12.7	22	0.8	Strip
CL-24	4.8	15.5	22	0.8	Strip
CL-73	4.8	12.7	19	0.8	Strip
CL-74	4.8	15.5	19	0.8	Strip

### M46C

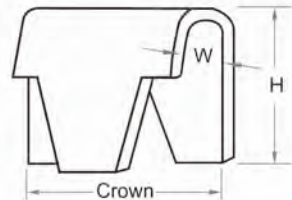

W	H	Crown	Thickness	Type	
CL-14	6.2	12.7	11	0.8	Strip
CL-16	6.2	14.5	11	0.8	Strip
CL-18	6.2	13.3	11	0.8	Strip
CL-20	6.2	14	11	0.8	Strip

### M45C

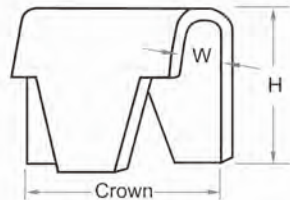

W	H	Crown	Thickness	Type	
CL-13	4.8	10.7	11	0.8	Strip
CL-15	4.8	10.0	11	0.8	Strip
CL-17	4.8	13.2	11	0.8	Strip

### M66L2

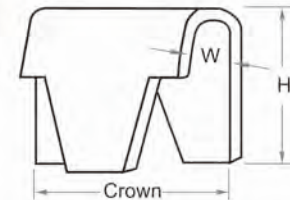

W	H	Crown	Thickness	Type	
CL-3	6.2	12.3	22	0.8	Strip
CL-4	6.2	14.1	22	0.8	Strip
CL-5	6.2	15.5	19	0.8	Strip
CL-71	6.2	12.7	19	0.8	Strip
CL-72	6.2	14.1	19	0.8	Strip

### M65LB

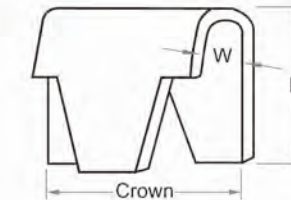

W	H	Crown	Thickness	Type	
CL-23	4.8	12.7	22	0.8	Strip
CL-24	4.8	15.5	22	0.8	Strip
CL-73	4.8	12.7	19	0.8	Strip
CL-74	4.8	15.5	19	0.8	Strip

### M46LB

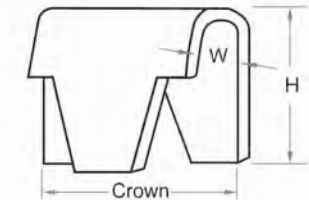

W	H	Crown	Thickness	Type	
CL-14	6.2	12.7	11	0.8	Strip
CL-16	6.2	14.5	11	0.8	Strip
CL-18	6.2	13.3	11	0.8	Strip
CL-20	6.2	14	11	0.8	Strip



**INDUSTRIAL STAPLING PLIER**



20 GA C-RING PLIER

**P88U**

**1/2" Crown Stapling Plier**

**FEATURES**

- High-speed operation
- Detachable magazine for quick jam clearing
- Second safety trigger
- Rubber comfort grip

**APPLICATIONS**

Spring Mattress / Furniture



**FASTENER**

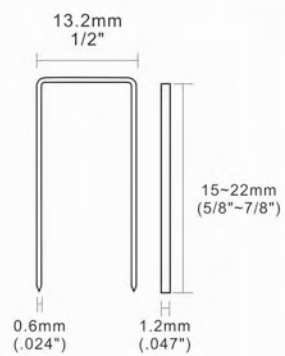

Type: 12J Fine Wire Staples

Gauge size: 20GA

Collation Type: Glued Strip

Weight	Length	Width	Height	Capacity	Air Inlet	Trigger	Operating pressure
2.18kg/4.81lbs	362mm/14.25"	80mm/3.14"	303mm/11.92"	200pcs	1/4"NPT	Trigger	60~100psi

20 GA C-RING PLIER

**P88U-B**

**1/2" Crown Stapling Plier**

**FEATURES**

- High-speed operation
- Detachable magazine for quick jam clearing
- Second safety trigger
- Rubber comfort grip
- Bottom staples loading magazine

**APPLICATIONS**

Spring Mattress / Furniture



**FASTENER**

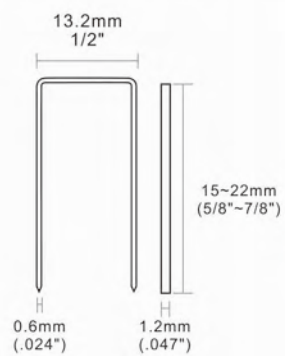

Type: 12J Fine Wire Staples

Gauge size: 20GA

Collation Type: Glued Strip

Weight	Length	Width	Height	Capacity	Air Inlet	Trigger	Operating pressure
2.17kg/4.78lbs	362mm/14.25"	80mm/3.14"	303mm/11.92"	200pcs	1/4"NPT	Trigger	60~100psi

**PIN NAILER**



**MP635B**

- 23GA. HEADLESS PINS 12~35mm (1/2"~1 3/8")
- 23GA. BRAD NAILS 12~35mm (1/2"~1 3/8")

CE  
Air pressure 70-100psi  
MADE IN CHINA





23 GA HEADLESS PINNER

## P625B

### 1" Headless Pinner

#### FEATURES

- Well-balanced ergonomically designed
- Powerful for heavy-duty applications
- Rear exhaust with embedded silencer
- Secondary trigger design
- Automatic adjustment magazine

#### APPLICATIONS

Windows / Door/Cabinets / Interior Decoration

#### FASTENER

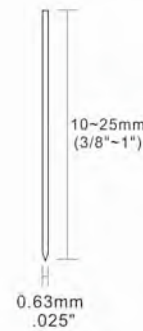

Type: Glued Strip Headless Pins

Gauge size: 23GA

Material: Galvanized, Stainless

Weight	Length	Width	Height	Capacity	Air Inlet	Trigger	Operating pressure
0.81kg/1.79lbs	230mm/9.05"	48mm/1.89"	177mm/6.97"	125pcs	1/4"NPT	Trigger	70~100psi



23 GA HEADLESS PINNER

## MP650B

### 2" Headless/Mini Brad Pinner

#### FEATURES

- Suitable for headed and headless pins
- Powerful for heavy-duty applications
- Rear exhaust with embedded silencer
- Secondary trigger design
- Automatic adjustment magazine

#### APPLICATIONS

Windows / Door / Cabinets / Interior Decoration

#### FASTENER

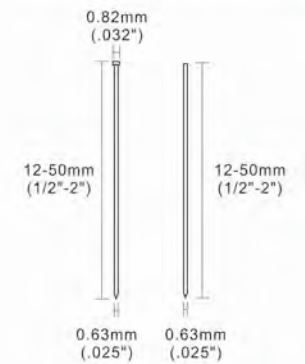

Type: Glued Strip Headless Pins  
Mini Brad Nails

Gauge size: 23GA

Material: Galvanized, Stainless

Weight	Length	Width	Height	Capacity	Air Inlet	Trigger	Operating Pressure
1.15kg/2.54lbs	230mm/9.06"	60mm/2.36"	226mm/8.90"	125pcs	1/4"NPT	Trigger	70~100psi



23 GA HEADLESS PINNER

## MP630B

### 1-3/16" Headless Pinner

#### FEATURES

- Well-balanced ergonomically designed
- Powerful for heavy-duty applications
- Rear exhaust with embedded silencer
- Secondary trigger design
- Automatic adjustment magazine

#### APPLICATIONS

Windows / Door / Cabinets / Interior Decoration

#### FASTENER



Type: Glued Strip Headless Pins

Gauge size: 23GA

Material: Galvanized, Stainless

Weight	Length	Width	Height	Capacity	Air Inlet	Trigger	Operating Pressure
0.85kg/1.83lbs	225mm/8.88"	52mm/2.05"	185mm/7.28"	125pcs	1/4"NPT	Trigger	70~100psi



21 GA HEADLESS PINNER

## MT840

### 1 1/2" Headless Mini Brad Pinner

#### FEATURES

- Suitable for headed and headless pins
- Powerful for heavy-duty applications
- Rear exhaust with embedded silencer
- Secondary trigger design
- Automatic adjustment magazine

#### APPLICATIONS

Windows / Door / Cabinets / Interior Decoration

#### FASTENER

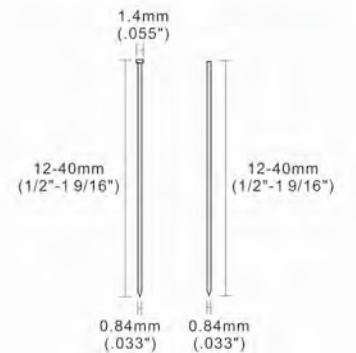

Type: Glued Strip Headless Pins  
Mini Brad Nails

Gauge size: 21GA

Material: Galvanized, Stainless

Weight	Length	Width	Height	Capacity	Air Inlet	Trigger	Operating Pressure
1.19kg/2.62lbs	256mm/10.08"	60mm/2.36"	208mm/8.18"	150pcs	1/4"NPT	Trigger	70~100psi



23 GA HEADLESS PINNER

## MP635B

### 1-3/8" Headless/Mini Brad Pinner

#### FEATURES

- Well-balanced ergonomically designed
- Powerful for heavy-duty applications
- Rear exhaust with embedded silencer
- Secondary trigger design
- Automatic adjustment magazine

#### APPLICATIONS

Windows / Door / Cabinets / Interior Decoration

#### FASTENER

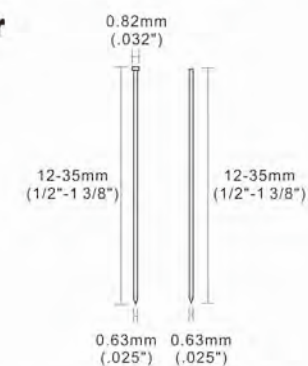

Type: Glued Strip Headless Pins  
Mini Brad Nails

Gauge size: 23GA

Material: Galvanized, Stainless

Weight	Length	Width	Height	Capacity	Air Inlet	Trigger	Operating Pressure
0.91kg/2.01lbs	223mm/8.78"	52mm/2.05"	196mm/7.72"	100pcs	1/4"NPT	Trigger	70~100psi



21 GA HEADLESS PINNER

## MT850

### 2" Headless/Mini Brad Pinner

#### FEATURES

- Suitable for headed and headless pins
- Powerful for heavy-duty applications
- Rear exhaust with embedded silencer
- Secondary trigger design
- Automatic adjustment magazine

#### APPLICATIONS

Windows / Door / Cabinets / Interior Decoration

#### FASTENER

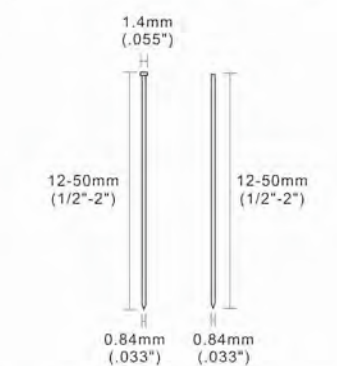

Type: Glued Strip Headless Pins  
Mini Brad Nails

Gauge size: 21GA

Material: Galvanized, Stainless

Weight	Length	Width	Height	Capacity	Air Inlet	Trigger	Operating Pressure
1.3kg/2.87lbs	256mm/10.7"	60mm/2.36"	227mm/8.93"	150pcs	1/4"NPT	Trigger	70~100psi



# STAPLER



## 21 GA FINE WIRE STAPLER 8016B 1/2" Fine Wire Stapler



### FEATURES

- Compact and light weight design
- Ergonomic handle with rubber comfort grip
- Durable driver and bumper for long life

### APPLICATIONS

Upholstery / Furniture / Cabinets / Car Seat / Picture Frames

### FASTENER

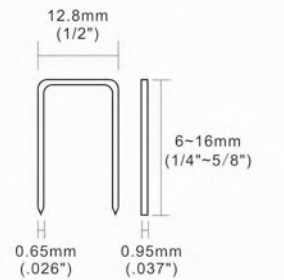





Model	Weight	Length	Width	Height	Capacity	Air Inlet	Trigger	Operating pressure
8016B	0.92kg/2.03lbs	207mm/8.15"	45mm/1.77"	145mm/5.71"	125pcs	1/4"NPT	Trigger	60~100psi
1013J	0.90kg/1.98lbs	207mm/8.15"	45mm/1.77"	145mm/5.71"	100pcs	1/4"NPT	Trigger	60~100psi
7116B	0.92kg/2.03lbs	207mm/8.15"	45mm/1.77"	145mm/5.71"	180pcs	1/4"NPT	Trigger	60~100psi
1010F	0.92kg/2.01lbs	207mm/8.15"	45mm/1.77"	145mm/5.71"	140pcs	1/4"NPT	Trigger	60~100psi
1416B	0.95kg/2.09lbs	210mm/8.27"	45mm/1.77"	150mm/5.91"	160pcs	1/4"NPT	Trigger	60~100psi

Type: Fine Wire Staples

Gauge size: 21GA

Collation Type: Glued Strip

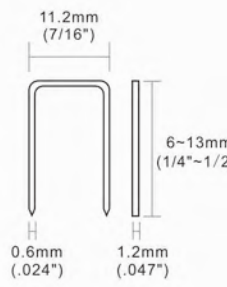
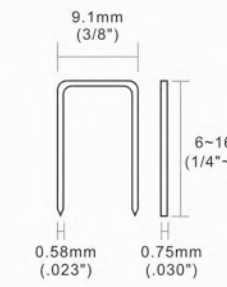
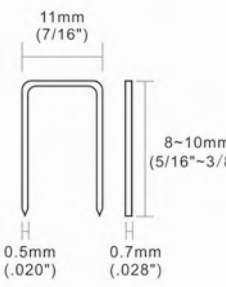
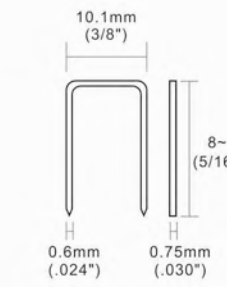

1013J	7116B	1010F	1416B
			
20 GA FINE WIRE STAPLER	22 GA FINE WIRE STAPLER	22 GA FINE WIRE STAPLER	22 GA FINE WIRE STAPLER
			
Type: Fine Wire Staples Gauge size: 20GA Collation Type: Glued Strip	Type: Fine Wire Staples Gauge size: 22GA Collation Type: Glued Strip	Type: Fine Wire Staples Gauge size: 23GA Collation Type: Glued Strip	Type: Fine Wire Staples Gauge size: 22GA Collation Type: Glued Strip



**21 GA** **MT8016**  
FINE WIRE STAPLER **1/2" Crown Wire Stapler**



- FEATURES**
- Compact and light weight design
  - Built in silencer makes soft noise
  - Rear exhaust keeps oil off fabric and face
  - Ergonomic handle with rubber comfort grip

**APPLICATIONS**  
Upholstery / Furniture / Cabinets / Car Seat / Picture Frames

**FASTENER**

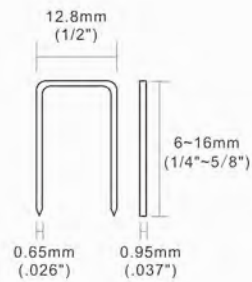

Model	Weight	Length	Width	Height	Capacity	Air Inlet	Trigger	Operating pressure
MT8016	0.95kg/2.09lbs	221mm/8.70"	43mm/1.69"	145mm/5.71"	150pcs	1/4"NPT	Trigger	60~100psi
MT7116	0.93kg/2.07lbs	221mm/8.70"	43mm/1.69"	150mm/5.91"	180pcs	1/4"NPT	Trigger	60~100psi
MT1416	0.93kg/2.07lbs	213mm/8.39"	43mm/1.69"	145mm/5.71"	180pcs	1/4"NPT	Trigger	60~100psi
MT8416	0.93kg/2.07lbs	213mm/8.39"	43mm/1.69"	145mm/5.71"	150pcs	1/4"NPT	Trigger	60~100psi

**Type:** Fine Wire Staples  
**Gauge size:** 21GA  
**Collation Type:** Glued Strip



**21 GA** **MT8016S**  
FINE WIRE STAPLER **1/2" Crown Fine Wire Stapler**



- FEATURES**
- Secondary trigger, safe for the operator
  - Compact and light weight design
  - Built in silencer makes soft noise
  - Rear exhaust keeps oil off fabric and face

**APPLICATIONS**  
Upholstery / Furniture / Cabinets / Car Seat / Picture Frames

**FASTENER**

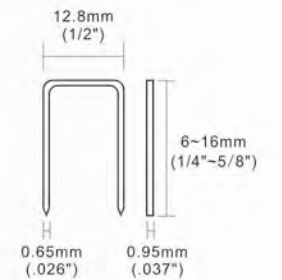

Model	Weight	Length	Width	Height	Capacity	Air Inlet	Trigger	Operating pressure
MT8016S	0.93kg/2.05lbs	213mm/8.39"	43mm/1.69"	145mm/5.71"	150pcs	1/4"NPT	Trigger	60~100psi
MT7116S	0.95kg/2.09lbs	213mm/8.39"	43mm/1.69"	150mm/5.91"	180pcs	1/4"NPT	Trigger	60~100psi
MT5016S	0.94kg/2.07lbs	213mm/8.39"	43mm/1.69"	145mm/5.71"	110pcs	1/4"NPT	Trigger	60~100psi
MT1416S	0.94kg/2.07lbs	213mm/8.39"	43mm/1.69"	145mm/5.71"	180pcs	1/4"NPT	Trigger	60~100psi
MT8416S	0.94kg/2.07lbs	213mm/8.39"	43mm/1.69"	145mm/5.71"	150pcs	1/4"NPT	Trigger	60~100psi

**Type:** Fine Wire Staples  
**Gauge Size:** 21GA  
**Collation Type:** Glued Strip



**MT7116**



**22 GA**  
FINE WIRE STAPLER

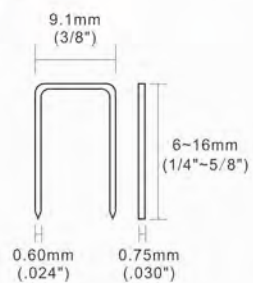

**Type:** Fine Wire Staples  
**Gauge size:** 22GA  
**Collation Type:** Glued Strip

**MT1416**



**22 GA**  
FINE WIRE STAPLER

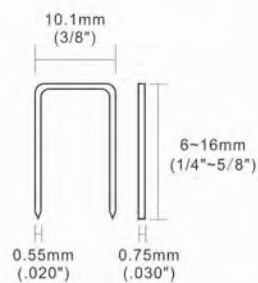

**Type:** Fine Wire Staples  
**Gauge size:** 22GA  
**Collation Type:** Glued Strip

**MT8416**



**21 GA**  
FINE WIRE STAPLER

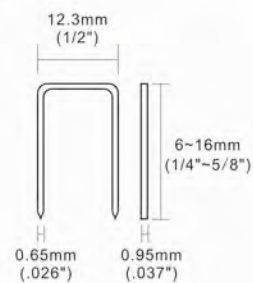

**Type:** Fine Wire Staples  
**Gauge size:** 21GA  
**Collation Type:** Glued Strip

**MT7116S**



**22 GA**  
FINE WIRE STAPLER

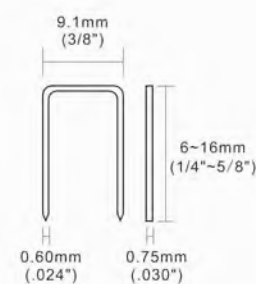

**Type:** Fine Wire Staples  
**Gauge size:** 22GA  
**Collation Type:** Glued Strip

**MT5016S**



**20 GA**  
FINE WIRE STAPLER

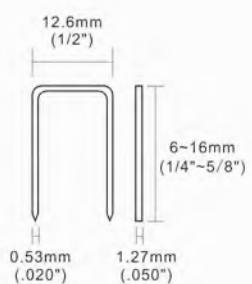

**Type:** Fine Wire Staples  
**Gauge size:** 20GA  
**Collation Type:** Glued Strip

**MT1416S**



**22 GA**  
FINE WIRE STAPLER

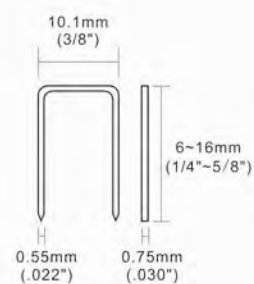

**Type:** Fine Wire Staples  
**Gauge size:** 22GA  
**Collation Type:** Glued Strip

**MT8416S**



**21 GA**  
FINE WIRE STAPLER

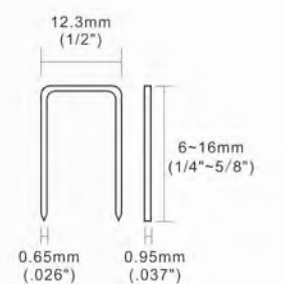

**Type:** Fine Wire Staples  
**Gauge size:** 21GA  
**Collation Type:** Glued Strip



**21 GA FINE WIRE STAPLER**  
**MT8016LN**  
**1/2" Crown Fine Wire Stapler**



- FEATURES**
- Compact and light weight design
  - Built in silencer makes soft noise
  - Rear exhaust keeps oil off fabric and face
  - Ergonomic handle with rubber comfort grip
  - Durable driver and bumper for long life

**APPLICATIONS**  
 Upholstery / Furniture / Cabinets / Car Seat / Picture Frames

**FASTENER**

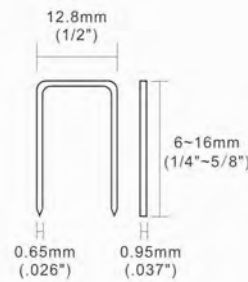

Model	Weight	Length	Width	Height	Capacity	Air Inlet	Trigger	Operating pressure
MT8016LN	1.03kg/2.27lbs	221mm/8.70"	43mm/1.69"	192mm/7.55"	150pcs	1/4"NPT	Trigger	70~100psi
MT7116LN	1.03kg/2.27lbs	221mm/8.70"	43mm/1.69"	192mm/7.55"	180pcs	1/4"NPT	Trigger	70~100psi
MT5016SLN	1.03kg/2.27lbs	221mm/8.70"	43mm/1.69"	192mm/7.55"	110pcs	1/4"NPT	Trigger	70~100psi

Type: Fine Wire Staples

Gauge size: 21GA

Collation Type: Glued Strip

**21 GA FINE WIRE STAPLER**  
**8016F2**  
**1/2" Crown Fine Wire Stapler**



- FEATURES**
- Built in silencer makes soft noise
  - Rear exhaust keeps oil off fabric and face
  - Ergonomic handle with rubber comfort grip
  - One hand magazine opening

**APPLICATIONS**  
 Upholstery / Furniture / Cabinets / Car Seat / Picture Frames

**FASTENER**

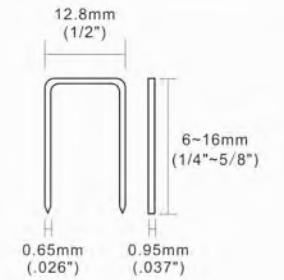

Weight	Length	Width	Height	Capacity	Air Inlet	Trigger	Operating Pressure
1.0kg/2.20lbs	232mm/9.13"	39mm/1.53"	146mm/5.75"	140pcs	1/4"NPT	Trigger	60~100psi

Type: Fine Wire Staples

Gauge Size: 21GA

Collation Type: Glued Strip

**MT7116LN**



**22 GA FINE WIRE STAPLER**

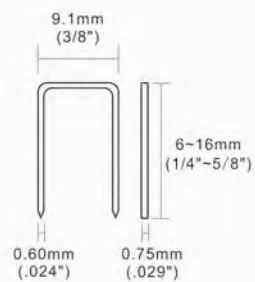

Type: Fine Wire Staples  
 Gauge size: 22GA  
 Collation Type: Glued Strip

**MT5016SLN**



**20 GA FINE WIRE STAPLER**

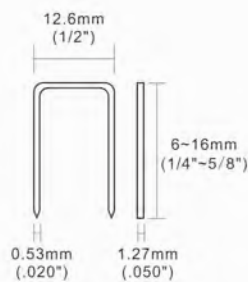

Type: Fine Wire Staples  
 Gauge size: 20GA  
 Collation Type: Glued Strip



Lengthen nose design easier to reach tight space



**22 GA FINE WIRE STAPLER**  
**7116**  
**3/8" Crown Fine Wire Stapler**



- FEATURES**
- Built in silencer makes soft noise
  - Rear exhaust keeps oil off fabric and face
  - Ergonomic handle with rubber comfort grip
  - One hand magazine opening

**APPLICATIONS**  
 Upholstery / Furniture / Cabinets / Car Seat / Picture Frames

**FASTENER**

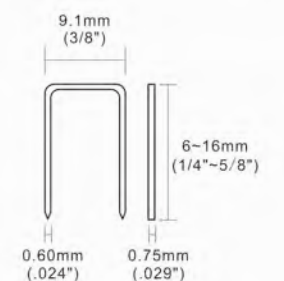

Weight	Length	Width	Height	Capacity	Air Inlet	Trigger	Operating Pressure
0.96kg/2.21lbs	240mm/9.45"	42mm/1.65"	150mm/5.91"	180pcs	1/4"NPT	Trigger	60~100psi

Type: Fine Wire Staples

Gauge Size: 22GA

Collation Type: Glued Strip



**20 GA FINE WIRE STAPLER** **MTP5016/MTP8016**  
**1/2" Fine Wire Stapler**

**FEATURES**

- Built in silencer
- Rear exhaust
- Rubber comfort grip

**APPLICATIONS**

Furniture / Cabinets / Car Seat /  
Picture Frame / Bedding

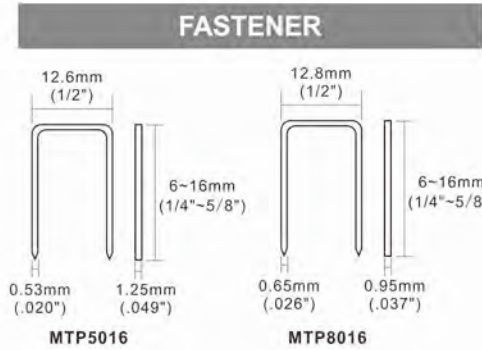

Model	Weight	Length	Width	Height	Capacity	Air Inlet	Trigger	Operating pressure
MTP5016	1.50kg/3.31lbs	225mm/8.86"	60mm/2.36"	230mm/9.06"	110pcs	1/4"NPT	Trigger	60~100psi
MTP8016	1.50kg/3.31lbs	225mm/8.86"	60mm/2.36"	230mm/9.06"	150pcs	1/4"NPT	Trigger	60~100psi

**Type:** Fine Wire Staples  
**Gauge Size:** 20GA/ 21GA  
**Collation Type:** Glued Strip

**21 GA FINE WIRE STAPLER** **8016-A/7116-A**  
**1/2" Crown Fine Wire Automatic Stapler**

**FEATURES**

- Secondary trigger to avoid accident
- Built in silencer makes soft noise
- Rear exhaust keeps oil off fabric and face
- Ergonomic handle with rubber comfort grip
- Rapid firing type for high efficiency

**APPLICATIONS**

Upholstery / Furniture / Cabinets /  
Car Seat / Picture Frames

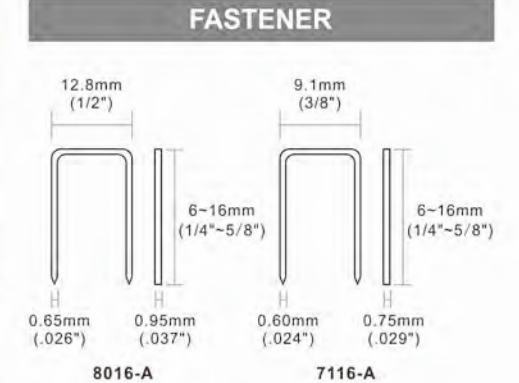

Model	Weight	Length	Width	Height	Capacity	Air Inlet	Trigger	Operating pressure
8016-A	1.0kg/2.20lbs	223mm/8.78"	41mm/1.61"	153mm/6.02"	140pcs	1/4"NPT	Trigger	60~100psi
7116-A	1.0kg/2.20lbs	223mm/8.78"	41mm/1.61"	153mm/6.02"	180pcs	1/4"NPT	Trigger	60~100psi

**Type:** Fine Wire Staples  
**Gauge Size:** 21GA/22GA  
**Collation Type:** Glued Strip

**20 GA FINE WIRE STAPLER** **422J/1022J**  
**1/4" Crown Fine Wire Stapler**

**FEATURES**

- Compact and light weight design
- Ergonomic handle with rubber comfort grip
- Durable driver and bumper for long life

**APPLICATIONS**

Upholstery / Furniture / Cabinets /  
Car Seat / Picture Frames

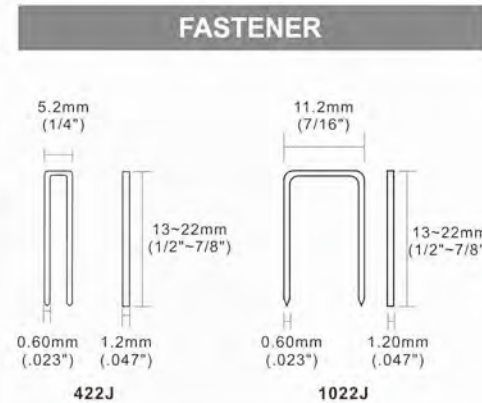

Model	Weight	Length	Width	Height	Capacity	Air Inlet	Trigger	Operating pressure
422J	1.11kg/2.45lbs	240mm/9.45"	63mm/2.48"	166mm/6.54"	100pcs	1/4"NPT	Trigger	60~100psi
1022J	1.30kg/2.87lbs	240mm/9.45"	55mm/2.16"	168mm/6.61"	100pcs	1/4"NPT	Trigger	60~100psi

**Type:** Fine Wire Staples  
**Gauge Size:** 20GA  
**Collation Type:** Glued Strip

**21 GA FINE WIRE STAPLER** **8016-AL/7116-AL**  
**1/2" Crown Fine Wire Automatic Stapler**

**FEATURES**

- Secondary trigger to avoid accident
- Rapid firing type for high efficiency
- Built in silencer makes soft noise
- Long magazine design
- Ergonomic handle with rubber comfort grip

**APPLICATIONS**

Upholstery / Furniture / Cabinets /  
Car Seat / Picture Frames

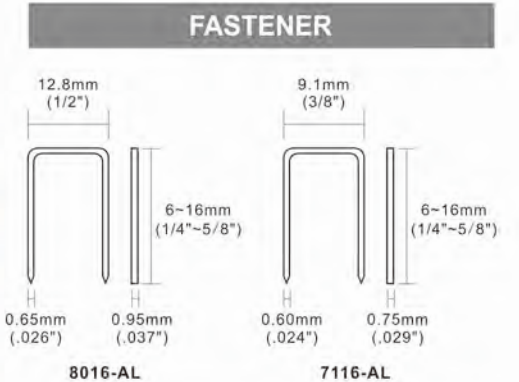

Model	Weight	Length	Width	Height	Capacity	Air Inlet	Trigger	Operating pressure
8016-AL	1.17kg/2.58lbs	355mm/13.98"	41mm/1.61"	153mm/6.02"	280pcs	1/4"NPT	Trigger	60~100psi
7116-AL	1.17kg/2.58lbs	355mm/13.98"	41mm/1.61"	153mm/6.02"	360pcs	1/4"NPT	Trigger	60~100psi

**Type:** Fine Wire Staples  
**Gauge Size:** 21GA/22GA  
**Collation Type:** Glued Strip





**18GA MEDIUM WIRE STAPLER**  
**440KB**  
**1/4" Crown Medium Wire Stapler**

**FEATURES**

- Powerful
- Rubber comfort grip
- Well-balanced

**APPLICATIONS**

Furniture / Cabinets / Windows / Door



Weight	Length	Width	Height	Capacity	Air Inlet	Trigger	Operating pressure
2.07kg/4.56lbs	310mm/12.20"	73mm/2.87"	252mm/9.92"	160pcs	1/4"NPT	Contact	70-120psi

**FASTENER**

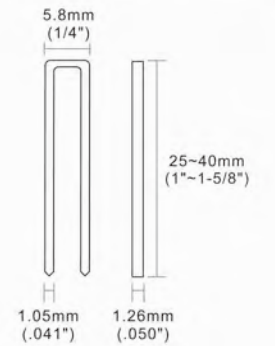

Type: Medium Wire Staples  
 Gauge Size: 18GA  
 Collation Type: Glued Strip

**18GA MEDIUM WIRE STAPLER**  
**MT432KLM**  
**1/4" Crown Medium Wire Stapler**

**FEATURES**

- Light weight
- Rubber comfort grip
- Single and rapid firing switchable mechanism
- Adjustable depth control

**APPLICATIONS**

Furniture / Cabinets / Windows / Door



Weight	Length	Width	Height	Capacity	Air Inlet	Trigger	Operating Pressure
1.45kg/3.2lbs	300mm/11.81"	60mm/2.36"	220mm/8.66"	160pcs	1/4"NPT	Contact	70-120psi

**FASTENER**

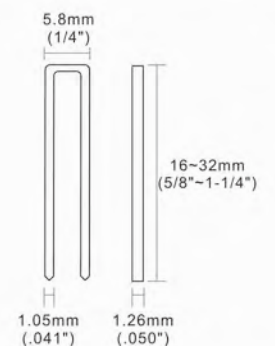

Type: Medium Wire Staples  
 Gauge Size: 18GA  
 Collation Type: Glued Strip

**18GA MEDIUM WIRE STAPLER**  
**425K**  
**1/4" Crown Medium Wire Stapler**

**FEATURES**

- Powerful
- Rubber comfort grip
- Well-balanced

**APPLICATIONS**

Outdoor Furniture / Cabinets / Windows / Door



Weight	Length	Width	Height	Capacity	Air Inlet	Trigger	Operating pressure
1.30kg/2.87lbs	240mm/9.45"	55mm/2.17"	168mm/6.61"	90pcs	1/4"NPT	Trigger	70-100psi

**FASTENER**

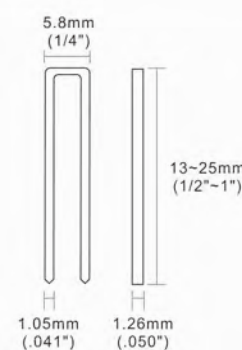

Type: Medium Wire Staples  
 Gauge Size: 18GA  
 Collation Type: Glued Strip

**18GA MEDIUM WIRE STAPLER**  
**MT440KLM**  
**1/4" Crown Medium Wire Stapler**

**FEATURES**

- Light weight
- Rubber comfort grip
- Single and rapid firing switchable mechanism
- Adjustable depth control

**APPLICATIONS**

Furniture / Cabinets / Windows / Door



Weight	Length	Width	Height	Capacity	Air Inlet	Trigger	Operating Pressure
1.97kg/4.34lbs	300mm/11.81"	70mm/2.75"	242mm/9.53"	160pcs	1/4"NPT	Contact	70-120psi

**FASTENER**

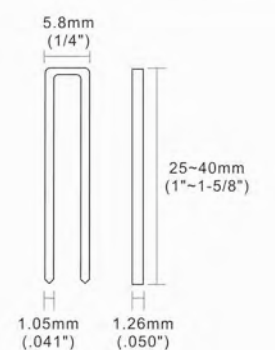

Type: Medium Wire Staples  
 Gauge Size: 18GA  
 Collation Type: Glued Strip



**18 GA** **9240B**

**5/16" Crown Medium Wire Stapler**



**FEATURES**

- Powerful
- Rubber comfort grip
- Well-balanced

**APPLICATIONS**

Furniture / Cabinets / Windows / Door

**FASTENER**

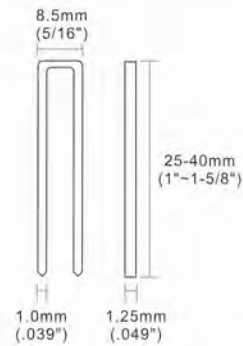

Type: Medium Fine Wire Staples

Gauge Size: 18GA

Collation Type: Glued Strip

Weight	Length	Width	Height	Capacity	Air Inlet	Trigger	Operating pressure
2.02kg/4.45lbs	310mm/12.20"	73mm/2.87"	246mm/9.68"	160pcs	1/4"NPT	Contact	70~120psi

**18 GA** **9240C**

**5/16" Crown Medium Wire Stapler**



**FEATURES**

- Powerful
- Rubber comfort grip
- Well-balanced
- Sensitive trigger for high efficiency

**APPLICATIONS**

Furniture / Cabinets / Windows / Door

**FASTENER**

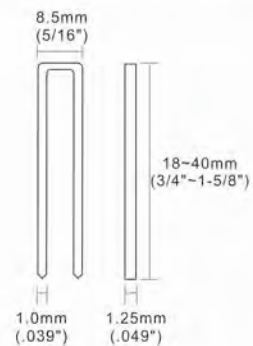

Type: Medium Fine Wire Staples

Gauge Size: 18GA

Collation Type: Glued Strip

Weight	Length	Width	Height	Capacity	Air Inlet	Trigger	Operating pressure
1.89kg/4.17lbs	366mm/14.41"	70mm/2.76"	244mm/9.61"	125pcs	1/4"NPT	Contact	70~120psi

**16 GA** **635TR**

**5/16" Crown Medium Wire Stapler**



**FEATURES**

- Powerful
- Rubber comfort grip
- Well-balanced
- Light weight
- Rapid firing

**APPLICATIONS**

Furniture / Cabinets / Windows / Door

**FASTENER**

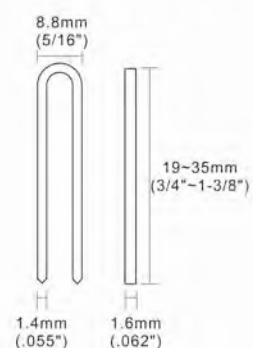

Type: Heavy Wire Staples

Gauge Size: 16GA

Collation Type: Glued Strip

Weight	Length	Width	Height	Capacity	Air Inlet	Trigger	Operating pressure
1.95kg/4.3lbs	310mm/12.20"	73mm/2.87"	246mm/9.68"	100pcs	1/4"NPT	Contact	70~120psi

**17 GA** **16 GA**

**MT-N851-H**

**7/16" Crown Heavy Stapler**



**FEATURES**

- Powerful for heavy-duty applications
- Well-balanced and light weight design
- Depth control with a simple adjustable knob
- Durable driver and bumper for long life

**APPLICATIONS**

Solid Wood Furniture / Sofa Frame / Wood Case / Packaging

**FASTENER**

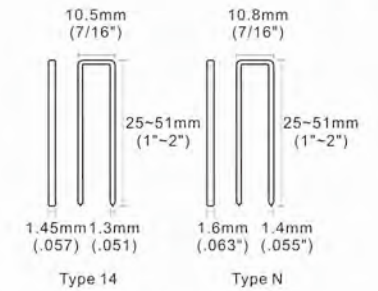

Type: Heavy Wire Staples

Gauge Size: 17GA/16GA

Collation Type: Glued Strip

Weight	Length	Width	Height	Capacity	Air Inlet	Trigger	Operating Pressure
2.52kg/5.56lbs	370mm/14.56"	93mm/3.66"	288mm/11.33"	140pcs	1/4"NPT	Contact	70~120psi

**17 GA** **16 GA**

**N851-L**

**7/16" Crown Heavy Stapler**



**FEATURES**

- Light weight
- Well-balanced
- Rapid firing
- Quick jams release

**APPLICATIONS**

Solid Wood Furniture / Sofa Frame / Wood Case / Packaging

**FASTENER**

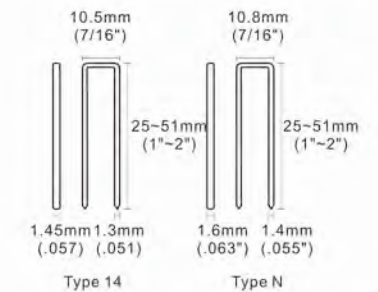

Type: Heavy Wire Staples

Gauge Size: 17GA/16GA

Collation Type: Glued Strip

Weight	Length	Width	Height	Capacity	Air Inlet	Trigger	Operating Pressure
2.25kg/4.96lbs	365mm/14.37"	83mm/3.27"	280mm/11.02"	140pcs	1/4"NPT	Contact	70~120psi

**16 GA**

**N851F**

**7/16" Crown Heavy Stapler**



**FEATURES**

- Powerful
- Well-balanced
- Rubber comfort grip

**APPLICATIONS**

Solid wood furniture / Wooden packing boxes  
Sofa frame / Sheathing roof / Decking  
Subflooring

**FASTENER**

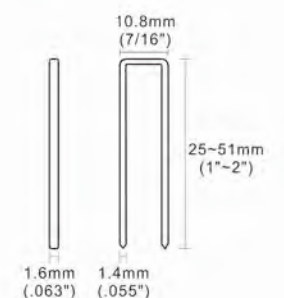

Type: Heavy Wire Staples

Gauge Size: 16GA

Collation Type: Glued Strip

Weight	Length	Width	Height	Capacity	Air Inlet	Trigger	Operating pressure
2.77kg/6.11lbs	345mm/13.58"	100mm/3.93"	297mm/11.69"	140pcs	1/4"NPT	Contact	70~120psi





17 GA HEAVY WIRE STAPLER  
16 GA HEAVY WIRE STAPLER

## 1440 7/16" Crown Heavy Stapler

### FEATURES

- Powerful for heavy-duty applications
- Well-balanced design
- Durable driver and bumper for long life

### APPLICATIONS

Solid Wood Furniture / Sofa Frame /  
Wood Case / Packaging

### FASTENER

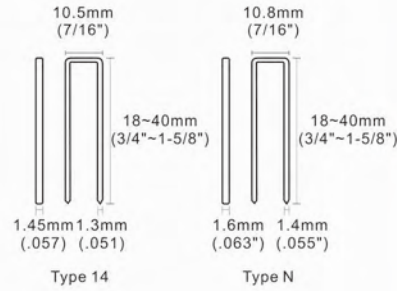

Type: Heavy Wire Staples

Gauge Size: 17GA/16GA

Collation Type: Glued Strip

Weight	Length	Width	Height	Capacity	Air Inlet	Trigger	Operating Pressure
1.93kg/4.25lbs	273mm/10.75"	70mm/2.76"	228mm/8.98"	110/100pcs	1/4"NPT	Contact	70-120psi



17 GA HEAVY WIRE STAPLER  
16 GA HEAVY WIRE STAPLER

## 1450 7/16" Crown Heavy Stapler

### FEATURES

- Powerful for heavy-duty applications
- Well-balanced design
- Durable driver and bumper for long life

### APPLICATIONS

Solid Wood Furniture / Sofa Frame /  
Wood Case / Packaging

### FASTENER

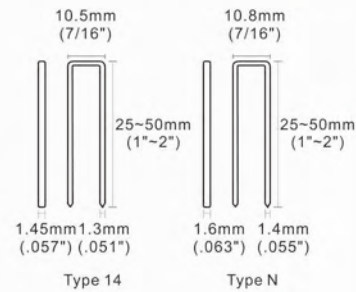

Type: Heavy Wire Staples

Gauge Size: 17GA/16GA

Collation Type: Glued Strip

Weight	Length	Width	Height	Capacity	Air Inlet	Trigger	Operating Pressure
2.48kg/5.47lbs	366mm/14.41"	70mm/2.76"	244mm/9.61"	150/140pcs	1/4"NPT	Contact	70-120psi



16 GA HEAVY WIRE STAPLER

## PW2638-L 1" Crown Heavy Stapler

### FEATURES

- Light weight
- Rapid firing
- Rubber comfort grip
- Quick jams release

### APPLICATIONS

Solid Wood Furniture / Sofa Frame /  
Wood Case / Packaging

### FASTENER

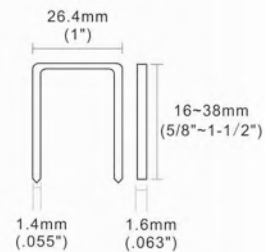

Type: Heavy Wire Staples

Gauge Size: 16GA

Collation Type: Glued Strip

Weight	Length	Width	Height	Capacity	Air Inlet	Trigger	Operating Pressure
2.5kg/5.51lbs	372mm/14.64"	83mm/3.26"	272mm/10.70"	140pcs	3/8"NPT	Contact	70-120psi

# BRAD NAILER







**18 GA** **MTF32**  
1-1/4" Brad Nailer

**FEATURES**

- 360° exhaust deflector
- Light weight & Well-balanced
- Powerful for heavy duty applications
- Ergonomic handle with rubber comfort grip

**APPLICATIONS**

Windows/Door/Cabinets/Interior Decoration

**FASTENER**

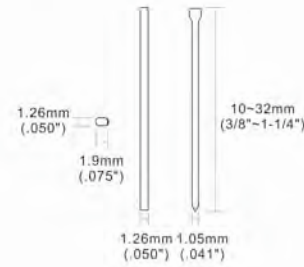

Type: Brad Nails

Gauge size: 18GA

Collation Type: Glued Strip

Weight	Length	Width	Height	Capacity	Air Inlet	Trigger	Operating pressure
1.09kg/2.40lbs	249mm/9.80"	57mm/2.24"	185mm/7.28"	100pcs	1/4"NPT	Trigger	60~100psi



**18 GA** **F50C**  
2" Brad Nailer

**FEATURES**

- 360° exhaust deflector
- Light weight & well-balanced
- Powerful for heavy duty applications
- Quick jams release

**APPLICATIONS**

Windows/Door/Cabinets/Interior Decoration

**FASTENER**

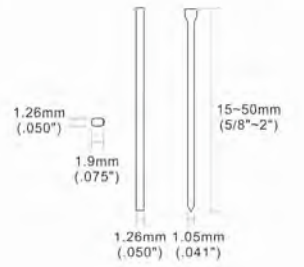

Type: Brad Nails

Gauge size: 18GA

Collation Type: Glued Strip

Weight	Length	Width	Height	Capacity	Air Inlet	Trigger	Operating pressure
1.38kg/3.04lbs	250mm/9.84"	57mm/2.24"	238mm/9.37"	100pcs	1/4"NPT	Contact	70~100psi



**18 GA** **F32**  
1-1/4" Brad Nailer

**FEATURES**

- Compact & durable gravity casting body
- Well-balanced
- Powerful for heavy duty applications
- Quick & easy loading

**APPLICATIONS**

Windows/Door/Cabinets/Interior Decoration

**FASTENER**

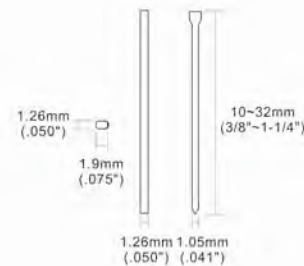

Type: Brad Nails

Gauge size: 18GA

Collation Type: Glued Strip

Weight	Length	Width	Height	Capacity	Air Inlet	Trigger	Operating pressure
1.23kg/2.71lbs	251mm/9.88"	62mm/2.44"	177mm/6.99"	100pcs	1/4"NPT	Trigger	60~100psi



**16 GA** **T50SA**  
2" Brad Nailer

**FEATURES**

- Compact & durable gravity casting body
- Well-balanced
- Powerful for heavy duty applications
- Quick and easy loading

**APPLICATIONS**

Windows/Door/Cabinets/Interior Decoration

**FASTENER**

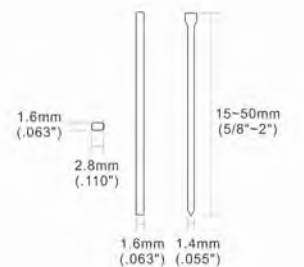

Type: Brad Nails

Gauge size: 16GA

Collation Type: Glued Strip

Weight	Length	Width	Height	Capacity	Air Inlet	Trigger	Operating pressure
1.78kg/4.10lbs	294mm/11.57"	77mm/3.03"	225mm/8.86"	100pcs	1/4"NPT	Contact	85~120psi



**18 GA** **F50G**  
2" Brad Nailer

**FEATURES**

- Compact & durable gravity casting body
- Well-balanced
- Powerful for heavy duty applications
- Quick & side loading

**APPLICATIONS**

Windows/Door/Cabinets/Interior Decoration

**FASTENER**

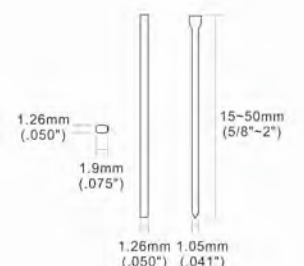

Type: Brad Nails

Gauge size: 18GA

Collation Type: Glued Strip

Weight	Length	Width	Height	Capacity	Air Inlet	Trigger	Operating pressure
1.36kg/3.00lbs	246mm/9.69"	66mm/2.60"	235mm/9.25"	100pcs	1/4"NPT	Contact	70~100psi



**16 GA** **T50SA-C**  
2" Brad Nailer

**FEATURES**

- Light weight and die-casting body
- Improved safety mechanism
- Powerful for heavy duty applications
- Quick and easy loading

**APPLICATIONS**

Windows/Door/Cabinets/Interior Decoration

**FASTENER**

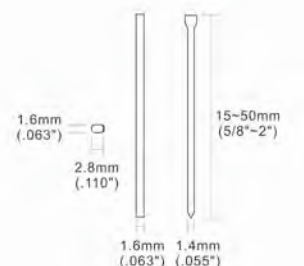

Type: Brad Nails

Gauge size: 16GA

Collation Type: Glued Strip

Weight	Length	Width	Height	Capacity	Air Inlet	Trigger	Operating pressure
1.97kg/4.34lbs	315mm/12.40"	81mm/3.19"	257mm/10.12"	100pcs	1/4"NPT	Contact	70~120psi





**16 GA BRAD NAILER**  
**T50MA**  
**2" Brad Nailer**

**FEATURES**

- Compact & durable gravity casting body
- Well-balanced
- Powerful for heavy duty applications
- Quick and easy loading

**APPLICATIONS**

Windows/Door/Cabinets/Interior Decoration

**FASTENER**

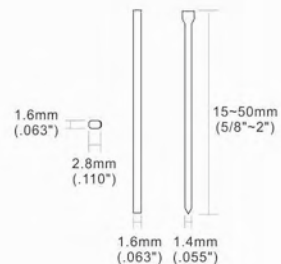

Weight	Length	Width	Height	Capacity	Air Inlet	Trigger	Operating pressure
2.44kg/5.38lbs	312mm/12.28"	78mm/3.07"	257mm/10.11"	100pcs	1/4"NPT	Contact	85~120psi

Type: Brad Nails  
Gauge size: 16GA  
Collation Type: Glued Strip

# CONCRETE AND STEEL NAILER



**16 GA BRAD NAILER**  
**FST50**  
**2" Brad Nailer**

**FEATURES**

- Compact & durable gravity casting body
- Well-balanced
- Powerful for heavy duty applications
- Quick and easy loading
- 2 in 1 brad nailer

**APPLICATIONS**

Windows/Door/Cabinets/Interior Decoration

**FASTENER**

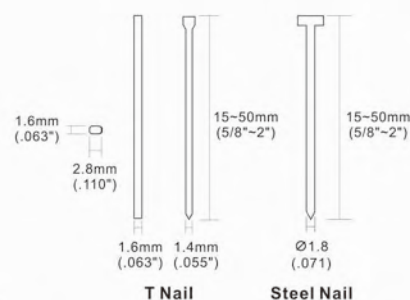

Weight	Length	Width	Height	Capacity	Air Inlet	Trigger	Operating pressure
1.59kg/3.51lbs	275mm/10.82"	62mm/2.44"	255mm/10.04"	70pcs	1/4"NPT	Contact	70~120psi

Type: Brad Nails  
Gauge size: 16GA  
Collation Type: Glued Strip

**16 GA BRAD NAILER**  
**T64A**  
**2-1/2" Brad Nailer**

**FEATURES**

- 360° exhaust deflector
- Light weight & Well-balanced
- Powerful for heavy duty applications
- Quick jams release

**APPLICATIONS**

Windows/Door/Cabinets/Interior Decoration

**FASTENER**

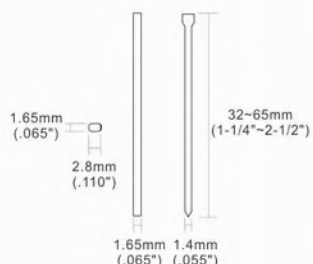

Weight	Length	Width	Height	Capacity	Air Inlet	Trigger	Operating pressure
1.75kg/3.88lbs	301mm/11.85"	73mm/2.87"	277mm/10.91"	100pcs	1/4"NPT	Contact	70~120psi

Type: Brad Nails  
Gauge size: 16GA  
Collation Type: Glued Strip



**14 GA** **ST38**  
**Concrete T Nailer**



**FEATURES**

- Well-balanced
- Powerful

**APPLICATIONS**

Windows/Door/Cabinets/Interior Decoration

**FASTENER**

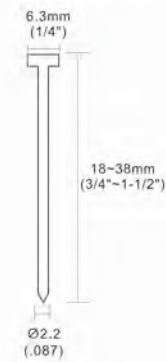

Type: Concrete Nails

Gauge size: 14GA

Weight	Length	Width	Height	Capacity	Air Inlet	Trigger	Operating pressure
1.99kg/4.39lbs	308mm/12.13"	77mm/3.03"	223mm/8.78"	80pcs	1/4"NPT	Contact	85~120psi

**14 GA** **ST64E/ST64L**  
**Concrete T Nailer**



**FEATURES**

- Well-balanced
- Powerful

**APPLICATIONS**

Windows/Door/Cabinets/Interior Decoration

**FASTENER**

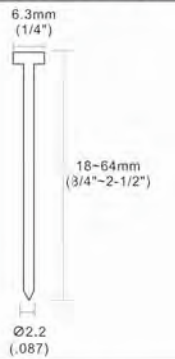

Type: Concrete Nails

Gauge size: 14GA

Model	Weight	Length	Width	Height	Capacity	Air Inlet	Trigger	Operating pressure
ST64E	2.94kg/6.48lbs	323mm/12.75"	101mm/3.98"	286mm/11.26"	80pcs	1/4"NPT	Contact	85~120psi
ST64L	3.06kg/6.75lbs	323mm/12.75"	101mm/3.98"	318mm/12.52"	80pcs	1/4"NPT	Contact	85~120psi

**14 GA** **ST64**  
**Concrete T Nailer**



**FEATURES**

- Well-balanced
- Powerful

**APPLICATIONS**

Windows/Door/Cabinets/Interior Decoration

**FASTENER**

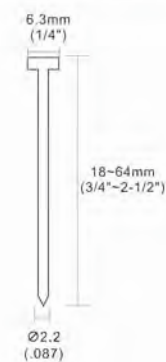

Type: Concrete Nails

Gauge size: 14GA

Weight	Length	Width	Height	Capacity	Air Inlet	Trigger	Operating pressure
2.96kg/6.53lbs	318mm/12.51"	95mm/3.75"	267mm/10.51"	80pcs	1/4"NPT	Contact	85~120psi

**CS3025**  
**1"Concrete and Steel Nailer**



**FEATURES**

- Works with standard compressed air
- Powerful for heavy duty applications
- Rubber comfort grip
- Durable driver and bumper for long life

**APPLICATIONS**

Wood to steel / Concrete / Drywall track to steel  
Concrete / Concrete furring

**FASTENER**

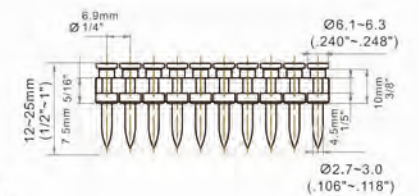

Type: Plastic Collected Concrete Nails

Collation Type: Plastic Collected

Weight	Length	Width	Height	Capacity	Air Inlet	Trigger	Operating pressure
2.78kg/6.13lbs	342mm/13.46"	104mm/4.09"	324mm/12.76"	30pcs	1/4"NPT	Contact	85-120psi

**14 GA** **ST64D**  
**Concrete T Nailer**



**FEATURES**

- Well-balanced
- Powerful

**APPLICATIONS**

Windows/Door/Cabinets/Interior Decoration

**FASTENER**

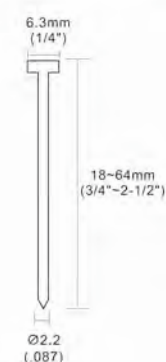

Type: Concrete Nails

Gauge size: 14GA

Weight	Length	Width	Height	Capacity	Air Inlet	Trigger	Operating pressure
3.23kg/7.12lbs	326mm/12.83"	100mm/3.94"	279mm/10.98"	80pcs	1/4"NPT	Contact	85-120psi

**MTCS3040L**  
**1 5/8"Concrete and Steel Nailer**



**FEATURES**

- Works with standard compressed air
- Powerful for heavy duty applications
- Rubber comfort grip
- Durable driver and bumper for long life

**APPLICATIONS**

Wood to steel / Concrete / Drywall track to steel  
Concrete / Concrete furring

**FASTENER**

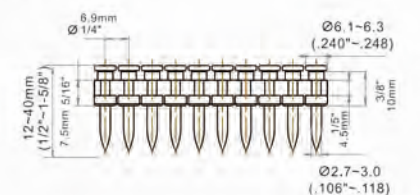

Type: Plastic Collected Concrete Nails

Collation Type: Plastic Collected

Weight	Length	Width	Height	Capacity	Air Inlet	Trigger	Operating pressure
2.90kg/6.39lbs	342mm/13.46"	104mm/4.09"	333mm/13.11"	30pcs	1/4"NPT	Contact	85~120psi



# PICTURE FRAME TACKER



## P515 Pneumatic Flex Point Tacker

### FEATURES

- Light weight & well-balanced
- Rubber comfort grip
- Ideal for high volume production
- Quick & easy bottom loading

### APPLICATIONS

Picture Frame

### FASTENER

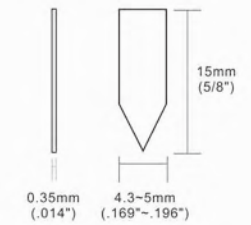

Weight	Length	Width	Height	Capacity	Air Inlet	Trigger	Operating pressure
0.90kg/1.98lbs	233mm/9.17"	49mm/1.93"	160mm/6.30"	290pcs	1/4"NPT	Trigger	60-100psi

Type: Flex Point Pins

## HM515 Manual Flex Tacker

### FEATURES

- Light weight & well-balanced
- Depth adjustment
- Quick & easy front loading

### APPLICATIONS

Picture Frame

### FASTENER

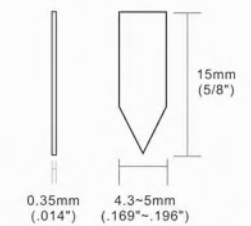

Weight	Length	Width	Height	Capacity	Air Inlet	Trigger	Operating pressure
0.62kg/1.37lbs	200mm/7.87"	40mm/1.57"	126mm/4.96"	145pcs	/	Manual	/

Type: Flex Point Pins

## V1015B V-Nailer

### FEATURES

- Light weight & well-balanced
- Rubber comfort grip
- Ideal for miter joint applications

### APPLICATIONS

Picture Frame

### FASTENER

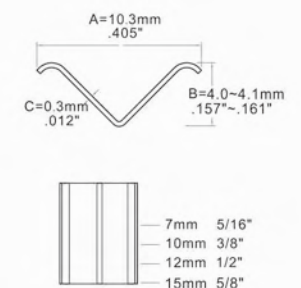

Weight	Length	Width	Height	Capacity	Air Inlet	Trigger	Operating Pressure
1.49kg/3.28lbs	270mm/10.62"	65mm/2.55"	208mm/8.18"	200pcs	1/4"NPT	Trigger	70-120psi

Type: V-Nails

Collation Type: Glued Strip





# DECO NAILER



## WS2513 1" Corrugated Nailers

### FEATURES

- Well-balanced & powerful
- Rubber comfort grip
- Ideal for miter joint applications

### APPLICATIONS

Picture Frame / Furniture / Cabinets



### FASTENER

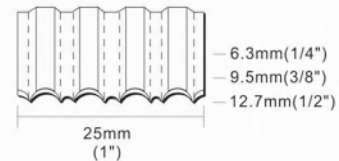

Type: Corrugated Nails

Collation Type: Glued Strip

Weight	Length	Width	Height	Capacity	Air Inlet	Trigger	Operating Pressure
3.37kg/7.43lbs	350mm/13.78"	92mm/3.62"	275mm/10.83"	100pcs	1/4"NPT	Contact	85~120psi

## WS1315 1/2" Corrugated Nailers

### FEATURES

- Light weight & well-balanced
- Rubber comfort grip
- Ideal for miter joint applications

### APPLICATIONS

Picture Frame / Furniture / Cabinets



### FASTENER

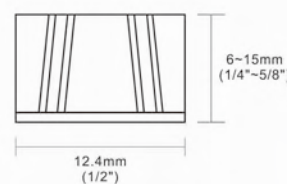

Type: Corrugated Nails

Collation Type: Glued Strip

Weight	Length	Width	Height	Capacity	Air Inlet	Trigger	Operating Pressure
2.01kg/4.43lbs	315mm/12.40"	81mm/3.19"	261mm/10.28"	156pcs	1/4"NPT	Contact	85~120psi





## ZN1170

### Deco Nailer

#### FEATURES

- Light weight
- Rubber comfort grip
- Magnetic nose piece

#### APPLICATIONS

Furniture / Picture / Shoes

#### FASTENER



MODEL	ZN0630	ZN0750	ZN0860
D(mm)	6.3	7.5	8.6
MODEL	ZN0960	ZN1080	ZN1170
D(mm)	9.6	10.8	11.7
MODEL	ZN1230	ZN1400	ZN1620
D(mm)	12.3	14.0	16.2
MODEL	ZN1820	ZN2030	ZN2230
D(mm)	18.2	20.3	22.3
MODEL	ZN2530	ZN2830	ZN3030
D(mm)	25.3	28.3	30.0

Weight	Length	Width	Height	Capacity	Air Inlet	Trigger	Operating Pressure
0.64kg/1.41lbs	208mm/8.81"	42mm/1.65"	174mm/6.85"	1pcs	1/4"NPT	Trigger	60~100psi



**Step1**  
Put the studs in plate



**Step2**  
Put the nose on the studs



**Step3**  
Actuate the trigger to shoot

# CARTON CLOSING STAPLER



## ZN-12

### Deco Automatic Nailer

#### FEATURES

- Speed control feeding
- Light weight & well-balanced
- Rapid & easy-loading
- Ideal for high-volume production

#### APPLICATIONS

Furniture / Picture / Shoes

#### FASTENER

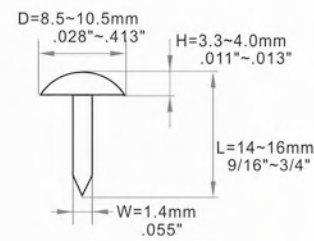

Weight	Length	Width	Height	Capacity	Air Inlet	Trigger	Operating Pressure
1.6kg/3.53lbs	245mm/9.64"	95mm/9.74"	200mm/7.87"	100pcs	1/4"NPT	Trigger	60~100psi

Type:Deco Nail

Collation Type: Galvanized, Stainless

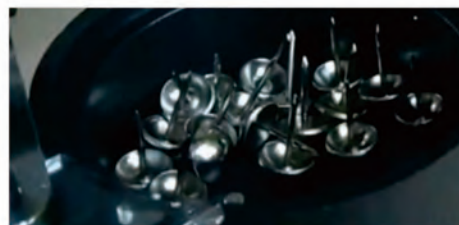

**Step1**  
Put the studs in the magazine set



**Step2**  
Adjust air inlet



**Step3**  
Actuate the trigger to shoot



**16 GA** **HB3515/HB3518**  
Manual Carton Closing Stapler



- FEATURES**
- Adjustable depth control
  - Light weight & well-balanced

**APPLICATIONS**  
Carton Box Closing

**FASTENER**

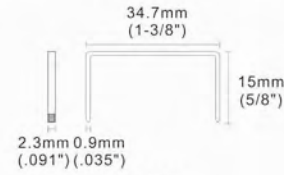

HB3515

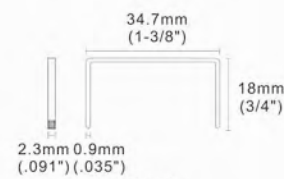

HB3518

**Type:** Carton Staples  
**Gauge Size:** 16GA  
**Collation Type:** Glued Strip

Weight	Length	Width	Height	Capacity	Air Inlet	Trigger	Operating Pressure
2.18kg/4.81lbs	432mm/17.01"	105mm/4.13"	267mm/10.51"	100pcs	/	Manual	/

**16 GA** **ADCS-19/ADCS-22**  
Pneumatic Carton Stapler

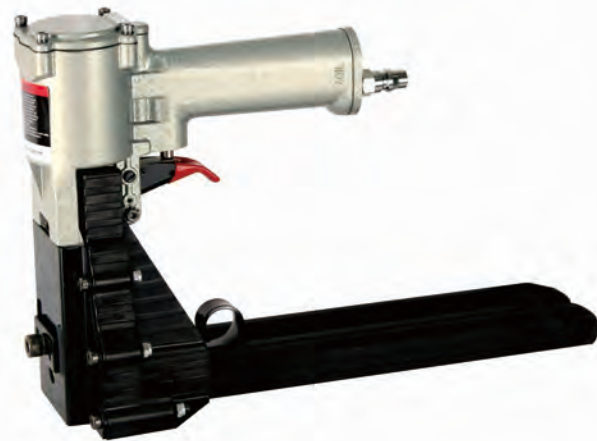

- FEATURES**
- Built in silencer for low noise
  - Light weight & well-balanced
  - Ideal for heavy-volume production

**APPLICATIONS**  
Carton Box Closing

**FASTENER**

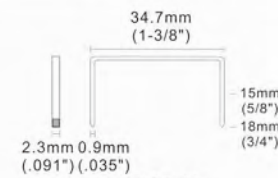

ADCS-19

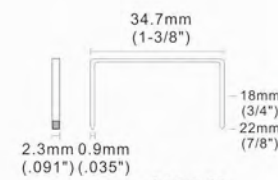

ADCS-22

**Type:** Carton Staples  
**Gauge size:** 16GA

Weight	Length	Width	Height	Capacity	Air Inlet	Trigger	Operating pressure
2.12kg/4.67lbs	342mm/13.46"	115mm/4.52"	220mm/8.66"	100pcs	1/4"NPT	Trigger	70~100psi

# INDUSTRIAL NAILS





# COIL NAILS

### FEATURES

1. Made of high-quality Q235 wire
2. Manufactured by standard, with high tensile strength
3. Precise nail pitch, angle between welding wire and nails, and nailing vertically
4. Strong fastening with deep tread
5. Even anti-rust paint, stronger corrosion resistance

### APPLICATIONS

Pallets / Crates / Wood case / Packaging



### SPECIFICATIONS

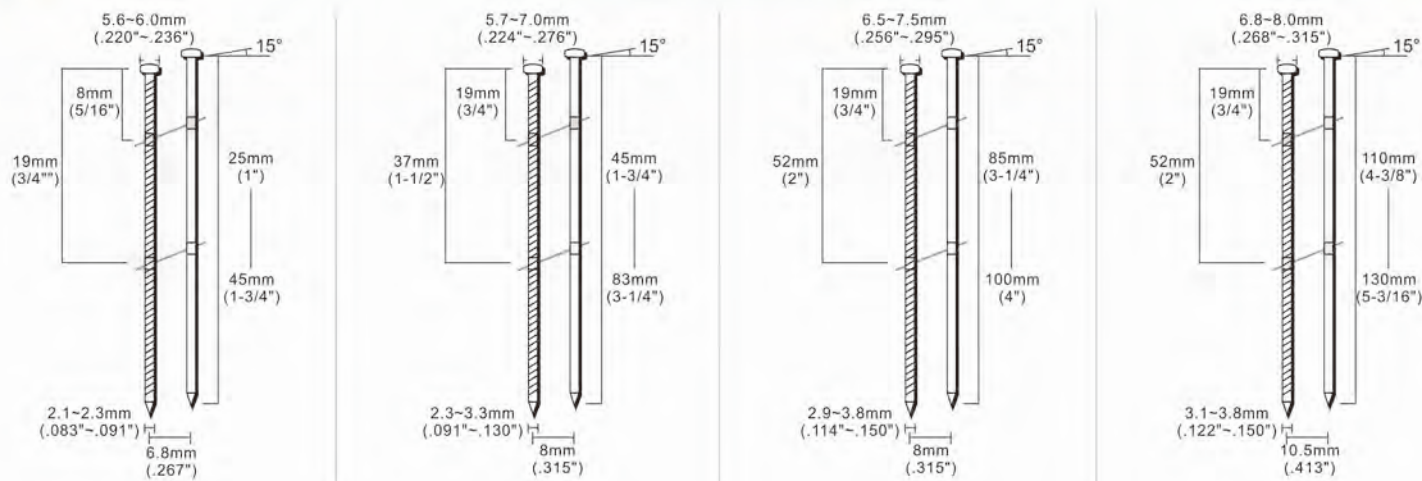

Shank Dia	Length	Head Dia	PCS/Roll
.083"(2.1mm)	1-1/4"~2"(32~50mm)	3/16"(5.1mm)	400PCS/COIL
.090"(2.3mm)	1-1/2"~2-1/4"(38~57mm)	1/5"(5.8mm)	350PCS/COIL
.099"(2.5mm)	1-3/4"~2-1/2"(45~64mm)	1/4"(6.1mm)	300PCS/COIL
.113"(2.87mm)	1-1/4"~3"(57~75mm)	1/4"(6.3mm)	250PCS/COIL
.120"(3.05mm)	2-3/8"~3-3/4"(60~90mm)	9/32"(7.1mm)	250PCS/COIL
.131"(3.33mm)	3"~4"(75~130mm)	9/32"(7.1mm)	120PCS/COIL



### Coil Nails Series



JUMBO COIL NAILS



ROOFING COIL NAILS

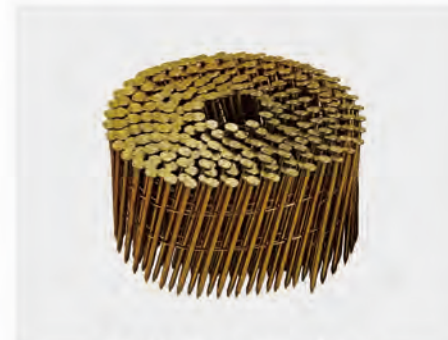

COMMON COIL NAILS



GALVANIZED COIL NAILS



HOT-DIP GALVANIZED COIL NAILS

### NAIL SPECIFICATIONS

MODEL	SIZE	DIAMETER	FINISH	PCS/BOX	BOX / CTN
2125	1"(25mm)	.083"(2.1mm)	Coating	20000	1
2127	1-1/8"(27mm)	.083"(2.1mm)	Coating	20000	1
2128	1-1/8"(28mm)	.083"(2.1mm)	Coating	16000	1
2132	1-1/4"(32mm)	.083"(2.1mm)	Coating	16000	1
2135	1-3/8"(35mm)	.083"(2.1mm)	Coating	16000	1
2138	1-1/2"(38mm)	.083"(2.1mm)	Coating	16000	1
2140	1-9/16"(40mm)	.083"(2.1mm)	Coating	16000	1
2145	1-3/4"(45mm)	.083"(2.1mm)	Coating	12000	1
2150	2"(50mm)	.083"(2.1mm)	Coating	12000	1
2155	2-1/8"(55mm)	.083"(2.1mm)	Coating	12000	1
2157	2-1/4"(57mm)	.083"(2.1mm)	Coating	12000	1
2345	1-3/4"(45mm)	.091"(2.3mm)	Coating	9000	1
2350B	2"(50mm)	.091"(2.3mm)	Coating	9000	1
2355	2-1/8"(55mm)	.091"(2.3mm)	Coating	9000	1
2357B	2-1/4"(57mm)	.091"(2.3mm)	Coating	9000	1
2360	2-3/8"(60mm)	.091"(2.3mm)	Coating	9000	1
2364	2-1/2"(64mm)	.091"(2.3mm)	Coating	9000	1
2545	1-3/4"(45mm)	.098"(2.5mm)	Coating	9000	1
2550	2"(50mm)	.098"(2.5mm)	Coating	9000	1
2557	2-1/4"(57mm)	.098"(2.5mm)	Coating	9000	1
2560	2-3/8"(60mm)	.098"(2.5mm)	Coating	9000	1
2564	2-1/2"(64mm)	.098"(2.5mm)	Coating	9000	1

### NAIL SPECIFICATIONS

MODEL	SIZE	DIAMETER	FINISH	PCS/BOX	BOX / CTN
2570	2-3/4"(70mm)	.098"(2.5mm)	Coating	6000	1
2575	3"(75mm)	.098"(2.5mm)	Coating	6000	1
2580	3-1/8"(80mm)	.098"(2.5mm)	Coating	6000	1
2970	2-3/4"(70mm)	.114"(2.9mm)	Coating	4500	1
2976	3"(76mm)	.114"(2.9mm)	Coating	4500	1
2980	3-1/8"(80mm)	.114"(2.9mm)	Coating	4500	1
2990	3-1/2"(90mm)	.114"(2.9mm)	Coating	4500	1
29100	4"(100mm)	.114"(2.9mm)	Coating	2700	1
3170	2-3/4"(70mm)	.122"(3.1mm)	Coating	2700	1
3175	3"(75mm)	.122"(3.1mm)	Coating	2700	1
3180	3-1/8"(80mm)	.122"(3.1mm)	Coating	2700	1
3190	3-1/2"(90mm)	.122"(3.1mm)	Coating	2700	1
3195	3-3/4"(95mm)	.122"(3.1mm)	Coating	2700	1
31100	4"(100mm)	.122"(3.1mm)	Coating	2700	1
31110	4-3/8"(110mm)	.122"(3.1mm)	Coating	2700	1
31120	4-13/16"(120mm)	.122"(3.1mm)	Coating	2700	1
3483	3 1/4"(83mm)	.130"(3.3mm)	Coating	2700	1
3490	3-1/2"(90mm)	.130"(3.3mm)	Coating	2700	1
3495	3-3/4"(95mm)	.130"(3.3mm)	Coating	2700	1
34100	4"(100mm)	.130"(3.3mm)	Coating	2700	1
34120	4-13/16"(120mm)	.130"(3.3mm)	Coating	2700	1
38130	5-3/16"(130mm)	.156"(3.8mm)	Coating	1440	1



**15<sup>GA</sup>** **16<sup>GA</sup>** **C-Ring Series**



C-RING SPECIFICATIONS						
MODEL	A	B	C	D	PCS	BOX
SC7	.071"(1.8mm)	1"(24mm)	.472"(12mm)	.217"-.315"(5.5-8mm)	10000	4
SC760	.063"(1.6mm)	5/8"(16.9mm)	.343"(8.7mm)	.102"-.142"(2.6-3.6mm)	18000	4
C56	.079"(2.0mm)	1-1/2"(39mm)	.807"(20.5mm)	.590"-.709"(15-18mm)	10000	1
C60	.079"(2.0mm)	2-3/4"(52mm)	1.083"(27.5mm)	.709"-.787"(18-20mm)	10000	1

**Clips Series**

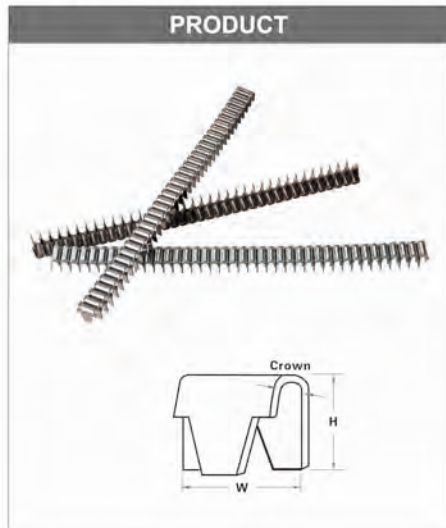

CLIPS SPECIFICATIONS						
Tool	Model	Crown	Height	Width	Thickness	Type
M66C	CL-3	6.2mm	12.3mm	22mm	0.8mm	Strip
	CL-4	6.2mm	14.1mm	22mm	0.8mm	Strip
	CL-5	6.2mm	15.5mm	19mm	0.8mm	Strip
	CL-71	6.2mm	12.7mm	19mm	0.8mm	Strip
	CL-72	6.2mm	14.1mm	19mm	0.8mm	Strip
M65C	CL-23	4.8mm	12.7mm	22mm	0.8mm	Strip
	CL-24	4.8mm	15.5mm	22mm	0.8mm	Strip
	CL-73	4.8mm	12.7mm	19mm	0.8mm	Strip
	CL-74	4.8mm	15.5mm	19mm	0.8mm	Strip
M46C	CL-14	6.2mm	12.7mm	11mm	0.8mm	Strip
	CL-16	6.2mm	14.5mm	11mm	0.8mm	Strip
	CL-18	6.2mm	13.3mm	11mm	0.8mm	Strip
	CL-20	6.2mm	14mm	11mm	0.8mm	Strip
M45C	CL-13	4.8mm	10.7mm	11mm	0.8mm	Strip
	CL-15	4.8mm	10mm	11mm	0.8mm	Strip
	CL-17	4.8mm	12.7mm	11mm	0.8mm	Strip

**12J Series**



STAPLE SPECIFICATIONS				
MODEL	SIZE	FINISH	BOX / QTY	BOX / CTN
1215J	5/8"(15mm)	Galv	3000	20
1218J	3/4"(18mm)	Galv	3000	20
1220J	13/16"(20mm)	Galv	3000	20
1222J	7/8"(22mm)	Galv	3000	20

**HEADLESS PIN SERIES**

PINS SPECIFICATIONS				
MODEL	SIZE	FINISH	PCS/BOX	BOX / CTN
P608	5/16"(8mm)	Copper Coating / Stainless	10000	48
P610	3/8"(10mm)	Copper Coating / Stainless	10000	48
P612	1/2"(12mm)	Copper Coating / Stainless	10000	48
P615	5/8"(15mm)	Copper Coating / Stainless	10000	48
P618	3/4"(18mm)	Copper Coating / Stainless	10000	48
P620	13/16"(20mm)	Copper Coating / Stainless	10000	48
P622	7/8"(22mm)	Copper Coating / Stainless	10000	48
P625	1"(25mm)	Copper Coating / Stainless	10000	48
P630	1 3/16"(30mm)	Copper Coating / Stainless	10000	48
P635	1-3/8"(35mm)	Copper Coating / Stainless	10000	24/48
P640	1-9/16"(40mm)	Copper Coating / Stainless	10000	24/48
P645	1-3/4"(45mm)	Copper Coating / Stainless	10000	24/48
P650	2"(50mm)	Copper Coating / Stainless	10000	24/48

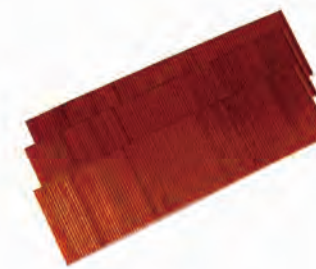

Copper



Stainless

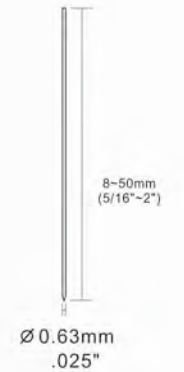

Plastic Box Packing



Small Pack



**22 GA**  
FINE WIRE  
STAPLE  
**71 Series**



STAPLE SPECIFICATIONS				
MODEL	SIZE	FINISH	PCS/BOX	BOX / CTN
7104	5/32"(4mm)	Galv	10000	20
7106	1/4"(6mm)	Galv	10000	20
7108	5/16"(8mm)	Galv	10000	20
7110	3/8"(10mm)	Galv	10000	20
7112	1/2"(12mm)	Galv	10000	20
7114	9/16"(14mm)	Galv	10000	20
7116	5/8"(16mm)	Galv	10000	20

**16 GA**  
HEAVY WIRE  
STAPLE  
**N Series**

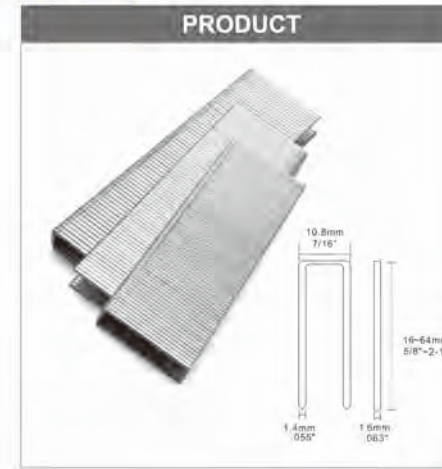

STAPLE SPECIFICATIONS				
MODEL	SIZE	FINISH	PCS/BOX	BOX / CTN
N16	5/8"(16mm)	Galv	10000	1
N19	3/4"(19mm)	Galv	10000	1
N22	7/8"(22mm)	Galv	10000	1
N25	1"(25mm)	Galv	10000	1
N28	1-1/8"(28mm)	Galv	10000	1
N32	1-1/4"(32mm)	Galv	10000	1
N35	1-3/8"(35mm)	Galv	10000	1
N38	1-1/2"(38mm)	Galv	10000	1
N40	1-9/16"(40mm)	Galv	10000	1
N45	1-3/4"(45mm)	Galv	10000	1
N50	2"(50mm)	Galv	10000	1

**21 GA**  
FINE WIRE  
STAPLE  
**80 Series**



STAPLE SPECIFICATIONS				
MODEL	SIZE	FINISH	PCS/BOX	BOX / CTN
8006	1/4"(6mm)	Galv	10000	20
8008	5/16"(8mm)	Galv	10000	20
8010	3/8"(10mm)	Galv	10000	10
8012	1/2"(12mm)	Galv	10000	10
8014	9/16"(14mm)	Galv	10000	10
8016	5/8"(16mm)	Galv	10000	10

**17 GA**  
HEAVY WIRE  
STAPLE  
**14 Series**



STAPLE SPECIFICATIONS				
MODEL	SIZE	FINISH	PCS/BOX	BOX / CTN
1415	19/32"(15mm)	Galv	10000	1
1416	5/8"(16mm)	Galv	10000	1
1418	3/4"(18mm)	Galv	10000	1
1422	7/8"(22mm)	Galv	10000	1
1425	1"(25mm)	Galv	10000	1
1430	1-3/16"(30mm)	Galv	10000	1
1432	1-1/4"(32mm)	Galv	10000	1
1434	1-11/32"(34mm)	Galv	10000	1
1435	1-3/8"(35mm)	Galv	10000	1
1440	1-5/8"(40mm)	Galv	10000	1
1445	1-3/4"(45mm)	Galv	10000	1
1450	2"(50mm)	Galv	10000	1
1460	2-3/8"(60mm)	Galv	10000	1

**20 GA**  
FINE WIRE  
STAPLE  
**50 Series**



STAPLE SPECIFICATIONS				
MODEL	SIZE	FINISH	PCS/BOX	BOX / CTN
5006	1/4"(6mm)	Galv	5000	20
5008	5/16"(8mm)	Galv	5000	20
5010	3/8"(10mm)	Galv	5000	20
5012	1/2"(12mm)	Galv	5000	20
5014	9/16"(14mm)	Galv	5000	20
5016	5/8"(16mm)	Galv	5000	20

**18 GA**  
MEDIUM WIRE  
STAPLE  
**92 Series**



STAPLE SPECIFICATIONS				
MODEL	SIZE	FINISH	PCS/BOX	BOX / CTN
9210	3/8" (10mm)	Galv	40000	1
9225	1"(25mm)	Galv	30000	1
9235	1-3/8"(35mm)	Galv	25000	1
9238	1-1/2"(38mm)	Galv	25000	1
9240	1-5/8"(40mm)	Galv	25000	1



**18 GA**  
MEDIUM WIRE  
STAPLE  
**90/K Series**



STAPLE SPECIFICATIONS				
MODEL	SIZE	FINISH	PCS/BOX	BOX / CTN
K13	1/2"(13mm)	Galv	5000	10
K16	5/8"(16mm)	Galv	5000	10
K19	3/4"(19mm)	Galv	5000	10
K22	7/8"(22mm)	Galv	5000	10
K25	1"(25mm)	Galv	5000	10
K28	1-1/8"(28mm)	Galv	5000	10
K30	1-3/16"(30mm)	Galv	5000	10
K32	1-1/4"(32mm)	Galv	5000	10
K35	1-3/8"(35mm)	Galv	5000	10
K38	1-1/2"(38mm)	Galv	5000	10
K40	1-5/8"(40mm)	Galv	5000	10

**18 GA**  
BRAD NAILS  
**F Brads Series**



BRAD NAIL SPECIFICATIONS				
MODEL	SIZE	FINISH	PCS/BOX	BOX / CTN
F10	3/8"(10mm)	Galv	5000	28
F15	9/16"(15mm)	Galv	5000	28
F16	5/8"(16mm)	Galv	5000	20
F18	3/4"(18mm)	Galv	5000	20
F19	3/4"(19mm)	Galv	5000	20
F20	16/19"(20mm)	Galv	5000	20
F25	1"(25mm)	Galv	5000	20
F30	1-3/16"(30mm)	Galv	5000	12
F32	1-1/4"(32mm)	Galv	5000	12
F35	1-3/8"(35mm)	Galv	5000	12
F38	1-1/2"(38mm)	Galv	5000	12
F40	1-9/16"(40mm)	Galv	5000	8
F45	1-3/4"(45mm)	Galv	5000	8
F50	2"(50mm)	Galv	5000	8

**16 GA**  
HEAVY WIRE  
STAPLE  
**P Series**

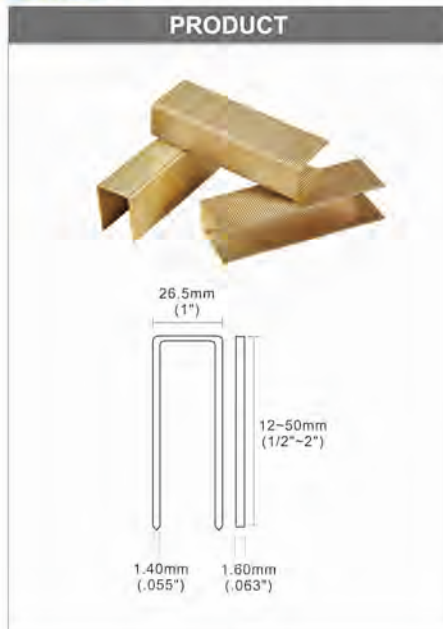

STAPLE SPECIFICATIONS				
MODEL	SIZE	FINISH	PCS/BOX	BOX / CTN
P12	1/2"(12mm)	Galv	5000	10
P16	5/8"(16mm)	Galv	5000	10
P19	3/4"(19mm)	Galv	5000	10
P20	13/16"(20mm)	Galv	5000	10
P22	7/8"(22mm)	Galv	5000	10
P25	1"(25mm)	Galv	5000	10
P32	1-1/4"(32mm)	Galv	5000	10
P38	1-1/2"(38mm)	Galv	5000	10
P45	1-3/4"(45mm)	Galv	5000	10
P50	2"(50mm)	Galv	5000	10

**16 GA**  
BRAD NAILS  
**T Brads Series**



BRAD NAIL SPECIFICATIONS				
MODEL	SIZE	FINISH	PCS/BOX	BOX / CTN
T15	9/16"(15mm)	Galv	2500	24
T20	13/16"(20mm)	Galv	2500	24
T22	7/8"(22mm)	Galv	2500	18
T25	1"(25mm)	Galv	2500	18
T30	1-3/4"(30mm)	Galv	2500	18
T32	1-1/4"(32mm)	Galv	2500	18
T35	1-3/8"(35mm)	Galv	2500	18
T38	1-1/2"(38mm)	Galv	2500	12
T40	1-9/16"(40mm)	Galv	2500	12
T45	1-3/4"(45mm)	Galv	2500	12
T50	2"(50mm)	Galv	2500	12

**16 GA**  
CARTON  
STAPLE  
**Carton Staples Series**



STAPLE SPECIFICATIONS				
MODEL	SIZE	FINISH	BOX / QTY	BOX / CTN
3515	9/16"(15mm)	Galv	2000	10
3518	3/4"(18mm)	Galv	1600	10
3522	7/8"(22mm)	Galv	1600	10



Cylinder Set



Cylinder Cap



O-ring



Goggles



**meite**  
Always wear goggles  
in the work area.

Bumper



Active Valve



Muzzle



Magazine



Driver Set



Lubricant



**meite** special lubricant  
Proper Lubrication is necessary for this pneumatic tool.  
Lube oil through the air inlets before and after for each time use if not using an oiler.  
Proper lubrication can increase the usage length of your tool also prevent rust from forming. Use MEITE lube oil for best performance.